

Quick User Guide

NMS-1000V
NMS-500



Sections

a)	Overview.....	3~5
b)	Application.....	6~7
c)	Before First Login.....	8~17
d)	Setup Wizard.....	18~22
e)	Main UI Introduction.....	23~25
f)	Dashboard Introduction.....	26~30
g)	Footer Introduction.....	31~32
h)	System Menu - Domain.....	33~38
i)	Device Information.....	39~48
j)	System Menu - AP Control.....	49~66
k)	System Menu - Refresh.....	67~68
l)	System Menu - System Configuration.....	69~76
m)	System Menu - Network Services	77~88
n)	System Menu - Maintenance.....	89~100
o)	System Menu - Exit.....	101~103
p)	HDMI Output.....	104~105
q)	Appendix.....	106~108

OVERVIEW

Overview

➤ Main Features:

Dashboard	Providing the at-a-glance view of system, device summary, traffic, PoE network status
Wizard Setup	Easy to use step-by-step guidance
Node Discovery	To detect PLANET managed devices available and allow AP grouping to accelerate AP management
Topology Viewer	A topology of network devices compliant with SNMP, ONVIF, Smart Discovery and LLTD Protocol
Event Reports	The status of a network can be reported via network alarm and system log
Alarm System	Popup alerts and email alerts for the administrator via the SMTP server
Batch Provisioning	Enabling multiple APs to be configured and upgraded at one time by using the designated profile
Coverage Heat Map	Real-time signal coverage of APs on the user-defined floor map to optimize Wi-Fi field deployment
Customized Profile	Allowing the creation and maintenance of multiple wireless profiles
Auto Provisioning	Multi-AP provisioning with one click
Cluster Management	Simplifying high-density AP management
Zone Plan	Optimizing AP deployment with actual signal coverage
Authentication	Built-in RADIUS server seamlessly integrated into the enterprise network
User Control	Allowing on-demand account creation and user-defined access policy
Scalability	Free system upgrade and AP firmware bulk upgrade capability

Overview

➤ Network Management Characteristics

- Built-in DHCP server
- Built-in RADIUS server
- SSL secure access
- Web-based GUI management interface
- SNMP v1, v2c, and v3 management
- Supports PLANET DDNS/Easy DDNS

➤ Industrial-grade Physical Hardware (NMS-1000V)

- 2 10/100/1000BASE-T Gigabit Ethernet RJ45 ports
- 2 USB 3.0 ports for configuration backup and restoration
- 1 audio line out (reserve)
- 1 HDMI interface
- 2 DB-9 COM1, COM2 (reserved)
- 1 3-pin DC power input terminal
- 1 2-pin connector for power on/off button (reserve)
- VESA (100 x 100) panel mount

➤ Industrial-grade Physical Hardware (NMS-500)

- 5 10/100/1000BASE-T Gigabit Ethernet RJ45 ports
- 1 2 USB 3.0 port for configuration backup and restoration
- 1 RS232-to-RJ45 console port (115200, 8, N, 1)
- Dimensions: 430 x 200 x 44 mm (W x D x H)
- Weight: 3kg
- Power: AC 100~240V, 50/60Hz to DC12V 5A max. adapter

➤ Physical Specifications (NMS-1000V)

Storage	2.5" 32G SATA3 HDD	
Touch LCD Size	NMS-1000V-12: 12.1" TFT-LCD	NMS-1000V-10: 10.1" TFT-LCD
Touch Type	Resistive Touch Window Projected Capacitive Touch	
Display Resolution	NMS-1000V-12: 1024 x 768	NMS-1000V-10: 1280 x 800
Display Luminance (cd/m ²)	NMS-1000V-12: 500	NMS-1000V-10: 350
Display Viewing Angle (H°/V°)	NMS-1000V-12: 160(H)/140(V)	NMS-1000V-10: 160(H)/160(V)
Display Contrast	NMS-1000V-12: 700:1	NMS-1000V-10: 800:1
Display Backlight Lifetime (hrs.)	NMS-1000V-12: 30,000 hrs.	NMS-1000V-10: 40,000 hrs.
Light Transmission (%)	Resistive Touch Window: over 80% Projected Capacitive Touch: over 90%	
Dimensions (W x D x H)	NMS-1000V-12: 319 x 51.7 x 245 mm	NMS-1000V-10: 285 x 49 x 189 mm
Weight	NMS-1000V-12: 2.9 kg	NMS-1000V-10: 2 kg
Enclosure	Aluminum Die-casting Chassis	
Power Requirements	DC IN 9~36V 60W adapter 12V 5A with terminal block AC 100~240V, 2.0A, 60~50Hz.	

APPLICATIONS

Applications

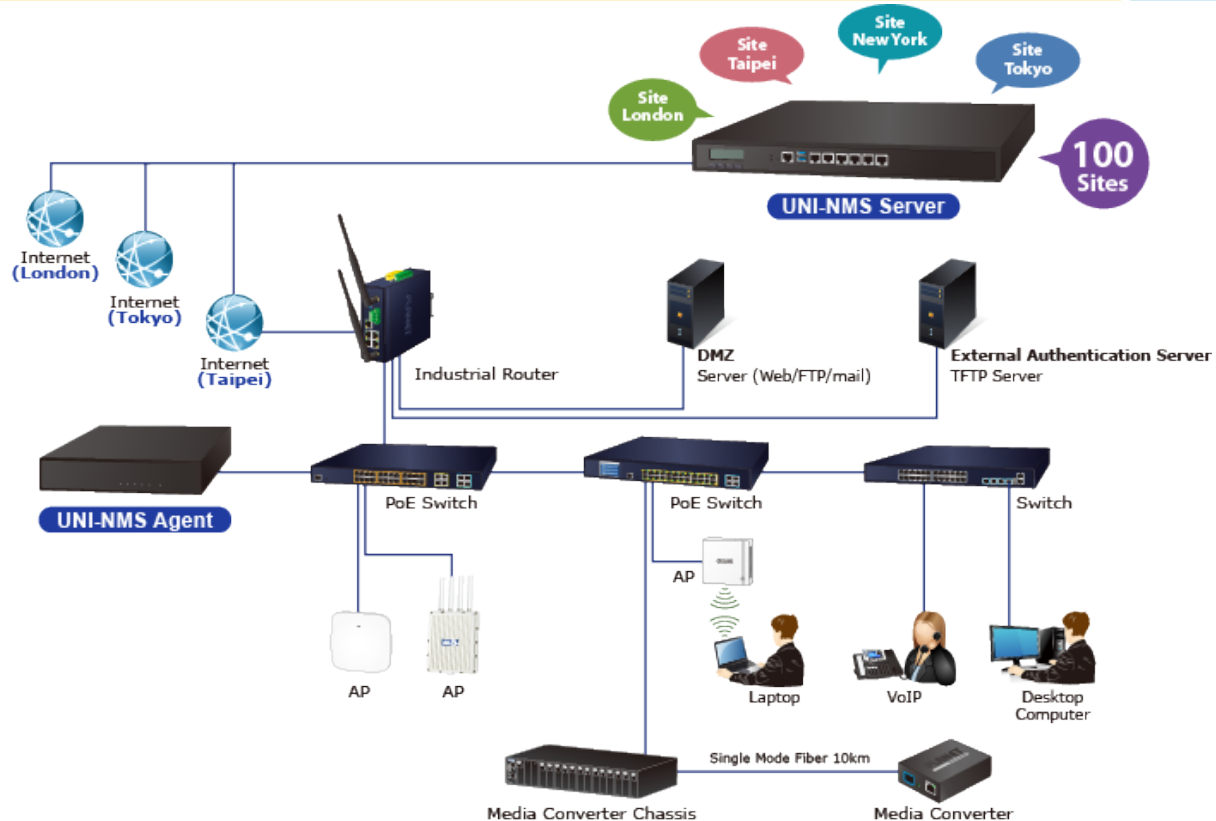

BEFORE FIRST LOGIN

Front & Rear Panels (NMS-1000V)

◆ Front Panel

Power LED (Green)



Front & Rear Panels

◆ Back Panel



9-36V DC IN



**Just connect NMS-1000V DC IN to turn on system.*

Front & Rear Panels

◆ Bottom Panel

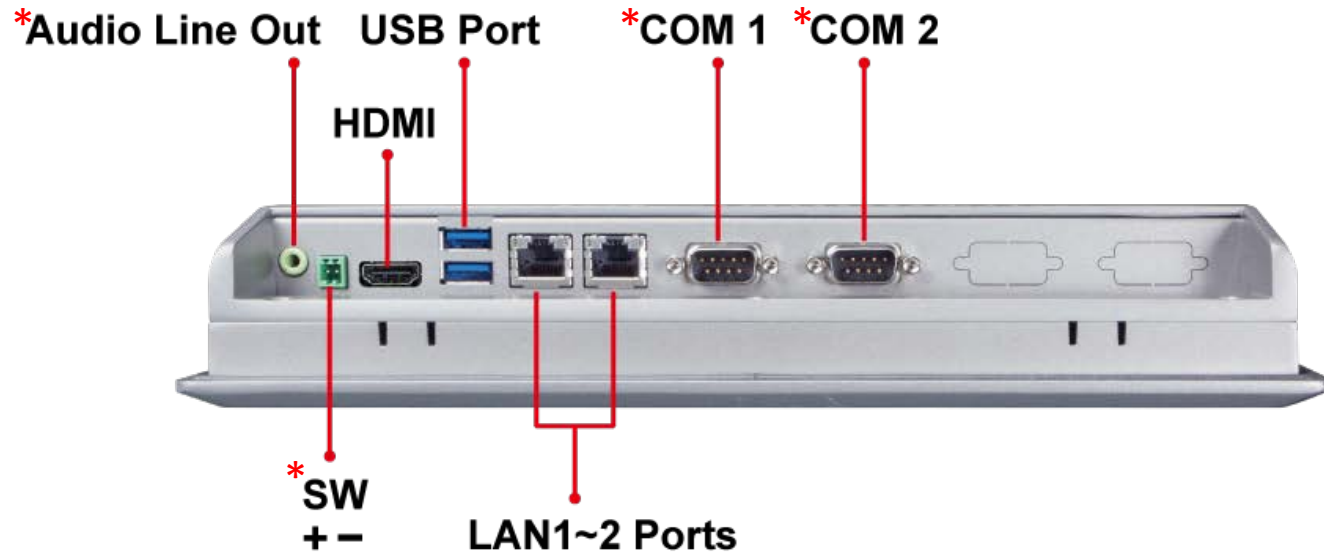

*.Function reserved

Front & Rear Panels (NMS-500)

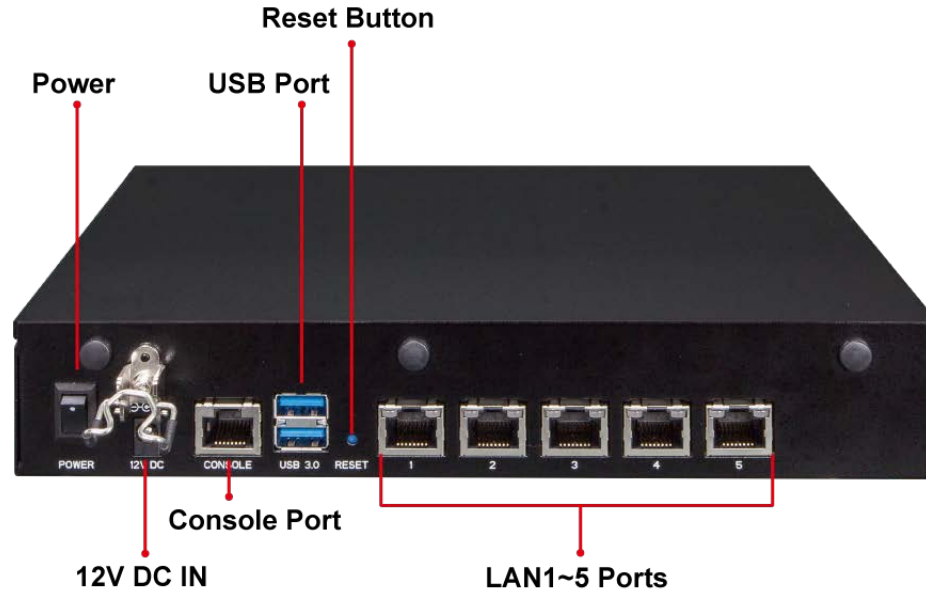
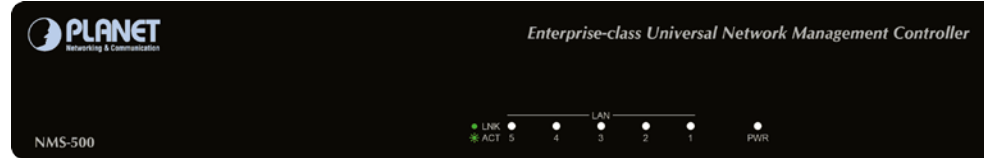

Device Setting

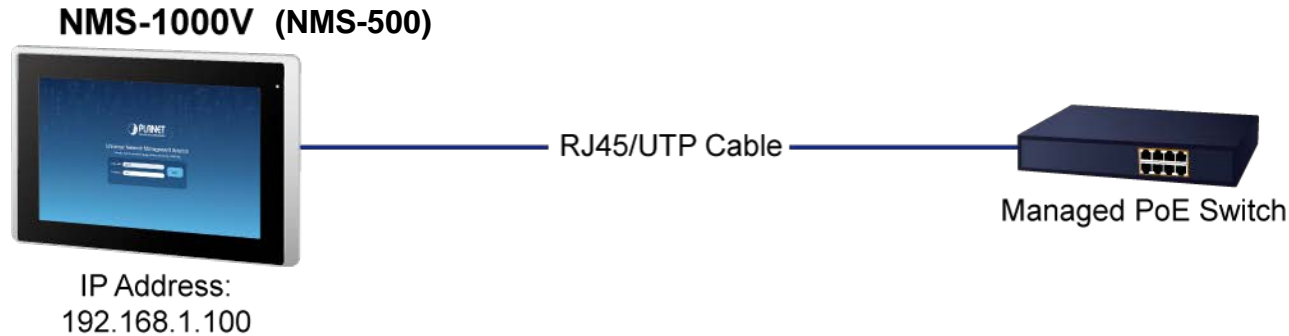

Switch: Log in to the Switch's Web User Interface and refer to the picture below to enable the SNMP and LLDP function as shown in Figures 1 and 2.

AP: Log in to the AP's Web User Interface and refer to Figure 3 below to configure the AP to "Managed AP". Then, click "Apply Change". To support SNMP AP, enable the SNMP function.

IP Cam: The ONVIF function is enabled by default.

Device Setting

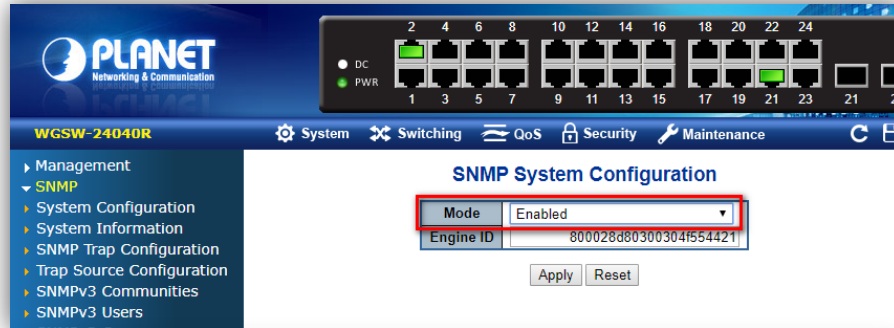

The screenshot shows the 'SNMP System Configuration' page for a PLANET WGSW-24040R device. The left sidebar lists navigation options under 'Management', with 'SNMP' selected. The main content area shows the 'SNMP System Configuration' form. The 'Mode' dropdown is set to 'Enabled' and is highlighted with a red box. The 'Engine ID' field contains the value '800026d80300304f54421'. Below the form are 'Apply' and 'Reset' buttons.

(Figure 1)

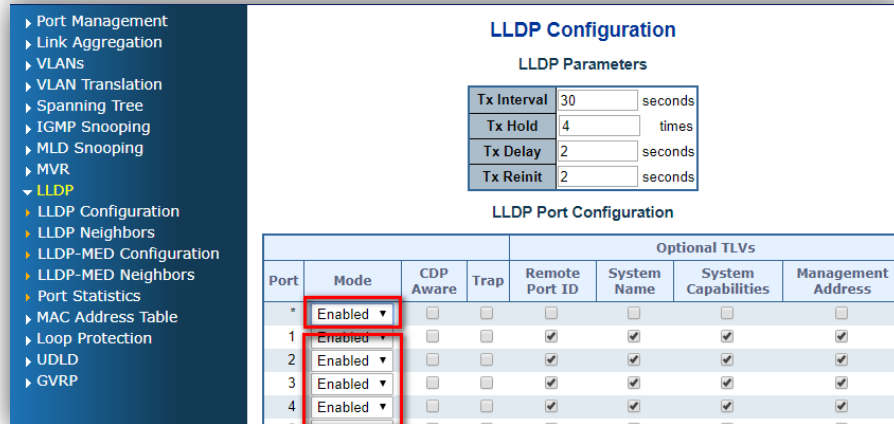

The screenshot shows the 'LLDP Configuration' page for the same device. The left sidebar lists navigation options under 'Port Management', with 'LLDP' selected. The main content area shows the 'LLDP Configuration' form. The 'LLDP Parameters' section includes input fields for 'Tx Interval' (30 seconds), 'Tx Hold' (4 times), 'Tx Delay' (2 seconds), and 'Tx Reinit' (2 seconds). Below this is the 'LLDP Port Configuration' table, which lists ports 1 through 4. The 'Mode' column for each port is set to 'Enabled' and is highlighted with a red box. The table also includes columns for 'CDP Aware', 'Trap', 'Remote Port ID', 'System Name', 'System Capabilities', and 'Management Address'.

Port	Mode	CDP Aware	Trap	Optional TLVs			
				Remote Port ID	System Name	System Capabilities	Management Address
*	Enabled	<input type="checkbox"/>	<input type="checkbox"/>	<input type="checkbox"/>	<input type="checkbox"/>	<input type="checkbox"/>	<input type="checkbox"/>
1	Enabled	<input type="checkbox"/>	<input type="checkbox"/>	<input checked="" type="checkbox"/>	<input checked="" type="checkbox"/>	<input checked="" type="checkbox"/>	<input checked="" type="checkbox"/>
2	Enabled	<input type="checkbox"/>	<input type="checkbox"/>	<input checked="" type="checkbox"/>	<input checked="" type="checkbox"/>	<input checked="" type="checkbox"/>	<input checked="" type="checkbox"/>
3	Enabled	<input type="checkbox"/>	<input type="checkbox"/>	<input checked="" type="checkbox"/>	<input checked="" type="checkbox"/>	<input checked="" type="checkbox"/>	<input checked="" type="checkbox"/>
4	Enabled	<input type="checkbox"/>	<input type="checkbox"/>	<input checked="" type="checkbox"/>	<input checked="" type="checkbox"/>	<input checked="" type="checkbox"/>	<input checked="" type="checkbox"/>

(Figure 2)

Device Setting

Setup Menu:	Operation Mode
> Operation Mode	AP Operation mode configuration is used to configure the managed AP administrative mode.
> Setup Wizard	
> WLAN1 (5 GHz)	<input type="radio"/> Standalone AP In Mode Standalone AP , the AP acts as an individual AP in the network, and you manage it by using the Administrator Web User Interface (UI), or SNMP.
> WLAN2 (2.4 GHz)	<input checked="" type="radio"/> Managed AP In Mode Managed AP , the AP is part of the PLANET Wireless AP controller System, and you manage it by using the WAPC Wireless Switch.
> TCP / IP Settings	<input type="checkbox"/> AP Controller IP Address <input type="text" value="0.0.0.0"/>
> Management	
> Logout	

(Figure 3)

Logging in NMS

- ◆ Username: admin
- ◆ Password: admin

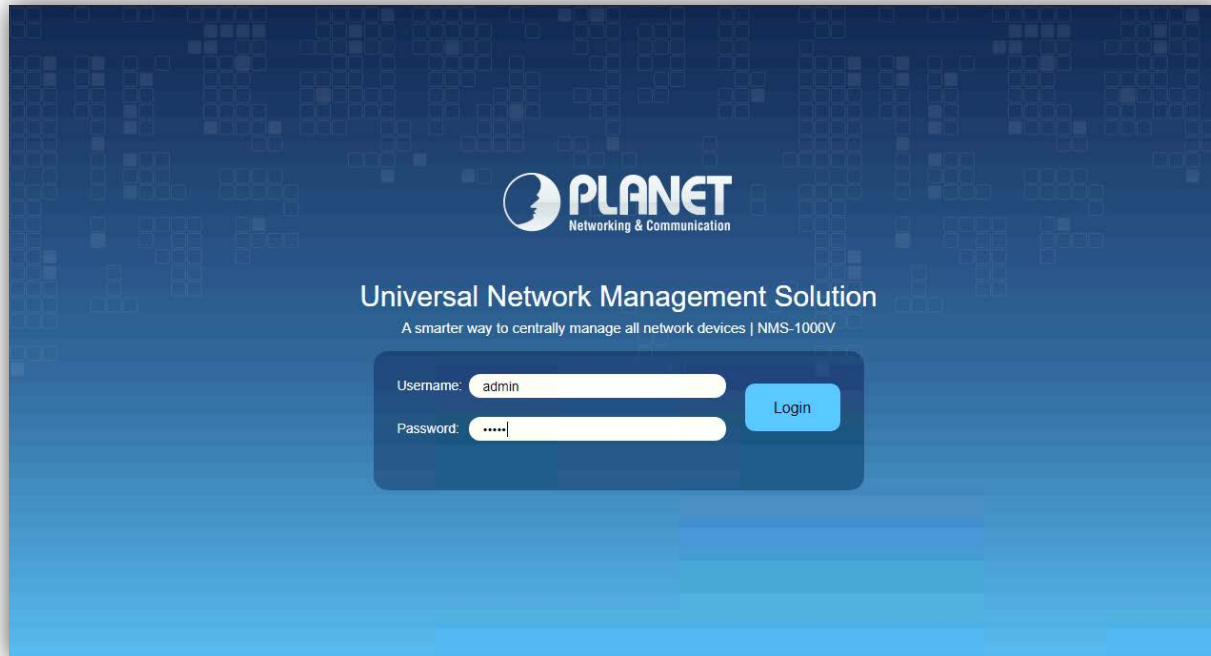
A screenshot of the PLANET Universal Network Management Solution (NMS-1000V) login page. The page has a dark blue background with a grid of small squares. At the top center is the PLANET logo. Below it, the text "Universal Network Management Solution" is displayed, followed by the tagline "A smarter way to centrally manage all network devices | NMS-1000V". In the center, there is a login form with two input fields: "Username:" containing "admin" and "Password:" containing "admin" (masked with dots). A blue "Login" button is positioned to the right of the password field.

PLANET
Networking & Communication

Universal Network Management Solution
A smarter way to centrally manage all network devices | NMS-1000V

Username: admin

Password:

Login

e.g. By NMS-1000V

Remote Logging in NMS

- ◆ Open Chrome/Firefox to log in the NMS.(Default IP: <https://192.168.1.100:8888>)
- ◆ Please use Chrome/Firefox to get fully supported. (UI Resolution [1280 x 768](#))

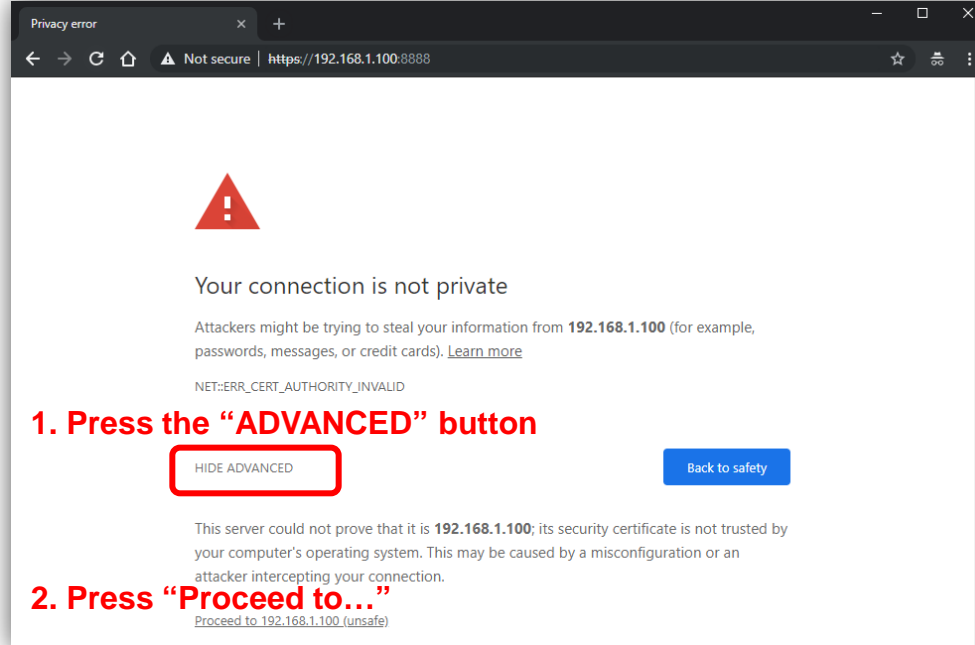

Privacy error

Not secure | <https://192.168.1.100:8888>

!

Your connection is not private

Attackers might be trying to steal your information from **192.168.1.100** (for example, passwords, messages, or credit cards). [Learn more](#)

NET::ERR_CERT_AUTHORITY_INVALID

1. Press the “ADVANCED” button

HIDE ADVANCED

Back to safety

This server could not prove that it is **192.168.1.100**; its security certificate is not trusted by your computer's operating system. This may be caused by a misconfiguration or an attacker intercepting your connection.

2. Press “Proceed to...”

[Proceed to 192.168.1.100 \(unsafe\)](#)

SETUP WIZARD

Account Modification

Steps to modifying account:

- ◆ 1. Please key in a new account, except using "admin"
- ◆ 2. New Password must include at least 1*[a~z], 1*[A~Z], 1*[0~9], 1*[~, !, @, ..., w/o "?"] and must contain at least 8 characters.

Account Modification

	Configuration
User Name	<input type="text" value="admin123"/>
Password	<input type="password" value="1qaz!QAZ"/>
Retype Password	<input type="password" value="....."/>

*Please key in a new account, except using "admin"
New Password must be included at least 1*[a~z], 1*[A~Z], 1*[0~9], 1*[~, !, @, ..., w/o "?"]

Next

IP Configuration Setting

- ◆ 1. Select “Static IP” or ” DHCP Client” for IP configuration setting.
- ◆ 2. IP status is shown in real time.

*If you want to use the SMTP Alarm function, you must at least enter one DNS server.

IP Configuration Setting

	Configuration	Status
Mode	Static IP ▾	Static
IP Address	10.1.0.199	10.1.0.199
Subnet Mask	255.255.254.0	255.255.254.0
Default Gateway	10.1.1.254	10.1.1.254
DNS Server 1	10.1.1.2	10.1.1.2
DNS Server 2	10.1.1.3	10.1.1.3

SNMP Preference Setting

- ◆ 1. Select Region for AP Control (ETSI or FCC).
- ◆ 2. And enter the RO/RW Community for device's SNMP.

SNMP Preference Setting

		Configuration
Region *	<input type="text" value="ETSI"/>	
RO Community	<input type="text" value="public"/>	
RW Community	<input type="text" value="private"/>	

*Select Region for AP Control (ETSI or FCC)

Devices Discovery

- ◆ 1. Press the Search button to discover PLANET devices.
- ◆ 2. Give a check to a box and press the “Add” button to add a device to the NMS system.
- ◆ 3. Press the Finish button to leave the Wizard mode and finish the start-up setting.

Devices Discovery

1. 3. Filter by Content

2.

<input type="checkbox"/>	Num.	Device Type	Model No.	Device IP	Device Description
<input type="checkbox"/>	1	Media Converter	N/A	10.1.1.250	WPS
<input type="checkbox"/>	2	Media Converter	N/A	10.1.1.252	WPS
<input type="checkbox"/>	3	Wireless	WNAP-C3220E	10.1.1.247	
<input type="checkbox"/>	4	Wireless	WNAP-C3220E	10.1.1.240	
<input type="checkbox"/>	5	Wireless	WNAP-C3220E	10.1.1.248	
<input type="checkbox"/>	6	N/A	GS-4210-48P4S	192.168.1.131	GS-4210-48P4S
<input type="checkbox"/>	7	N/A	WGSW-28040	10.1.1.220	Default Location

14 N/A VIP-1010PT 10.1.10.67 HD PoE IP Phone(1-Line)

4.

○ ○ ○ ●

MAIN UI INTRODUCTION

Home Page - Dashboard UI Structure

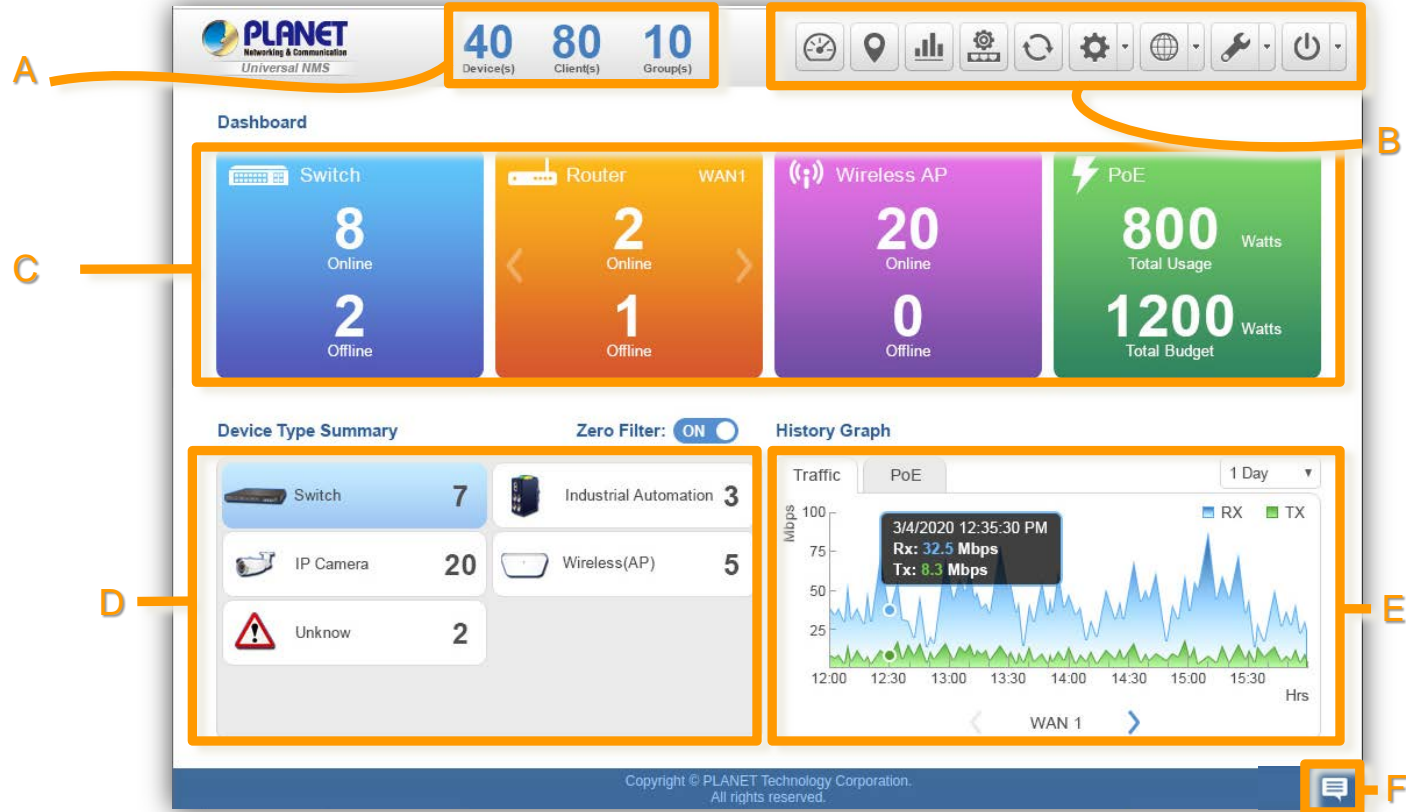

The dashboard is divided into several sections:

- A:** Header bar containing the PLANET logo, summary statistics (40 Device(s), 80 Client(s), 10 Group(s)), and a navigation menu with icons for Home, Location, Traffic, Settings, Refresh, Gear, Global, Tools, and Power.
- B:** Main dashboard area with four summary cards:
 - Switch:** 8 Online, 2 Offline
 - Router:** 2 Online, 1 Offline
 - Wireless AP:** 20 Online, 0 Offline
 - PoE:** 800 Watts Total Usage, 1200 Watts Total Budget
- C:** A line pointing to the summary cards in section B.
- D:** Device Type Summary section showing counts for:
 - Switch: 7
 - IP Camera: 20
 - Unknown: 2
 - Industrial Automation: 3
 - Wireless(AP): 5
- E:** History Graph section showing a traffic graph for PoE (WAN 1) over the last 1 day. A tooltip for 3/4/2020 12:35:30 PM shows Rx: 32.5 Mbps and Tx: 8.3 Mbps.
- F:** A chat icon in the bottom right corner.

Main Dashboard - Description

Item	Description	Remarks
A	Device Status Summary	<ol style="list-style-type: none"> 1. Roughly shows the system status: Current devices online (total online), clients (total active clients), device groups (total groups) 2. Click the PLANET Logo to connect to PLANET Web site.
B	System Menu	<p>From left to right:</p> <ol style="list-style-type: none"> 1. Dashboard: Provides the whole system view and wireless network status 2. Domain: Discovery / Device List / Topology View / Event / syslog page 3. Advanced Graph: future feature 4. AP Control: 1. Preference, 2. Profiles, 3. Control, 4. Map It and 5. Statistics 5. Refresh 6. System Configuration: Alert configuration, Date and Time, Interface, IP, Account, Wizard setting 7. Network Services: 1. Planet DDNS, 2. DHCP Server, 3. SMPT, 4. SNMP Agent, and 5. RADIUS Service, 8. Maintenance: System upgrade, backup and restoration, factory default, system setting. 9. Exit: Click to opt for the logout, reboot or shutting down of the system
C	Local Site Information	<ol style="list-style-type: none"> 1. Switch status, 2. Router status, 3. Access Point status and 4. Total PoE status, <p>*Click Device type button to filter each type of device via device list.</p>
D	Device Type Summary	Show the real-time total quantity of devices under different types
E	History Graph	Show the history graph of WAN traffic / total PoE usage and budget
F	Popup Alert Message Window	Open to show the system event instantly

DASHBOARD INTRODUCTION

Dashboard - Local Site Information

- **Local Site Information:** In this area, you can view 1. Switch, 2. Router, 3. Access Point online/off status and 4. Total PoE usage and budget status.
- Click the Router “>” button to see the WAN real-time traffic throughput of Mbps, Kbps... Click the Router “<” button to go back to status.



Dashboard (Home)

- Click the Device type button to filter each type device via device list.





Status	Group	MAC Address	Device Type	Model No.	Version	IP Address	Device Description	Authorization Status	Action
Online		a8:f7:e0:62:31:80	Industrial Switch	IGS-5225-8P4S	v3.440b200331	192.168.1.180	IE L2+ Managed PoE+ Switch	Online	⋮ 🔗 🗑️
Online		a8:f7:e0:65:e5:e1	Switch	GS-4210-8P2S	v2.305b200330	192.168.1.148	L2/L4 Managed PoE Switch	Online	⋮ 🔗 🗑️

- **Switch:** Click the “Switch Button” to filter the type of Switch, Industrial Switch, and Media Converter.
- **Router:** Click the “Router Button” to filter the type of Router.
- **Wireless AP:** Click the “Wireless AP Button” to filter the type of Wireless (AP).











Dashboard - Device Type Summary

- **Device Type Summary** : Show the real-time total quantity of devices under different types.
- **Open the “Zero Filter Button”** to filter the 0 quantity of devices type not shown. If this function is closed, you can see all types that NMS can manage.
- Click the Device type button to filter each type of device via device list.

Network Summary **Zero Filter: ON**

 Switch	1	 Industrial Switch	1
 IP Camera	1	 Router	1
 Wireless(AP)	3		

Network Summary **Zero Filter: OFF**

 Switch	1	 VoIP	0
 Industrial Switch	1	 IP Camera	1
 Media Converter	0	 IP Power	0
 Router	1	 Wireless(AP)	3
 Industrial Automation	0	 Unknown	0

Dashboard - History Graph

- **History Graph:** Show the history graph of WAN traffic / total PoE usage and budget.
- Press the “WAN” or “PoE” sheet button to change the type of history graph. Press the “Interval Button” to change the interval for day, week, or month. Then you can see the WAN traffic / total PoE usage and budget.

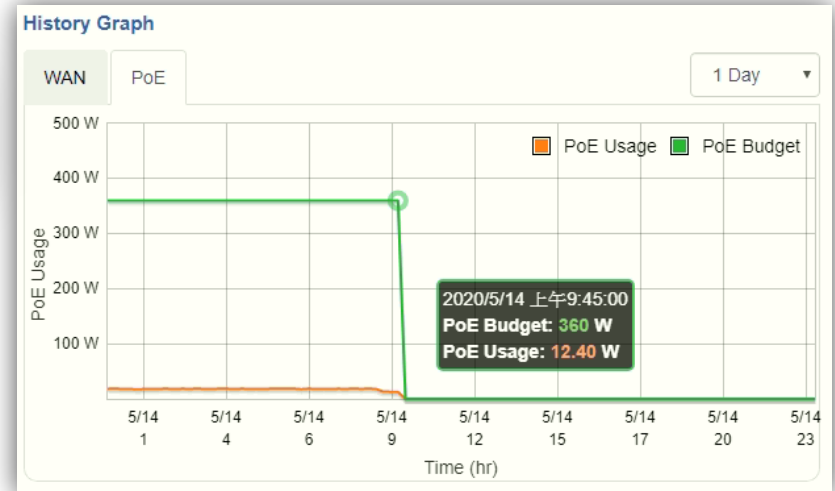
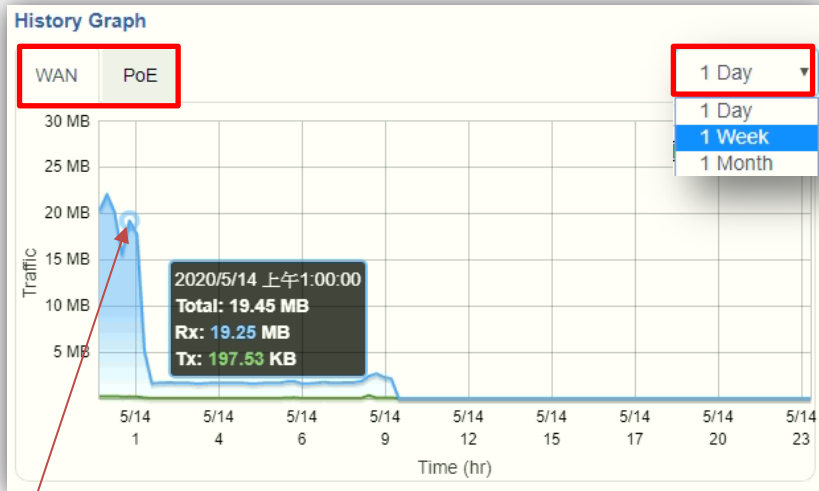

*Moving finger or mouse cursor on graph can let you see the detailed information.

FOOTER INTRODUCTION

Footer - Popup Alert Message

- **Popup Alert Message** : Click the “Message” icon (No. 1) to show the last 30 system events in popup window.
- The last event will be shown on the top page; press the “X” icon (No. 2) to close each message.

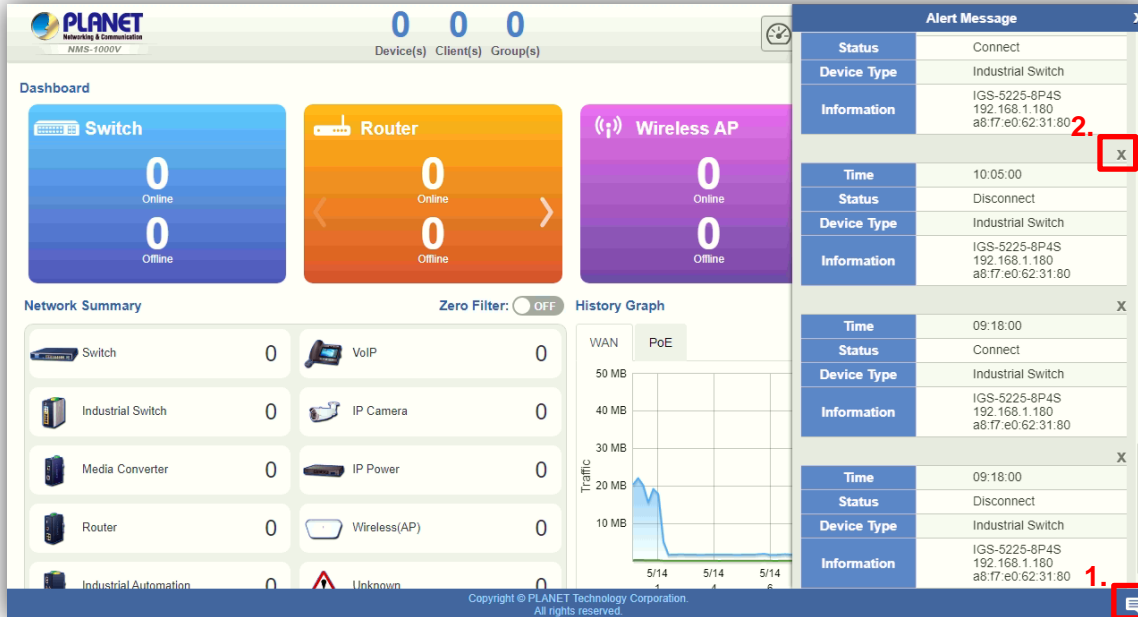

The screenshot shows the PLANET NMS-1000V dashboard. At the top, there are three status indicators: 0 Device(s), 0 Client(s), and 0 Group(s). The main dashboard area is divided into three colored panels: Switch (blue), Router (orange), and Wireless AP (purple), each showing 0 Online and 0 Offline devices. Below this is the Network Summary section with a Zero Filter set to OFF, listing various device types and their counts. A History Graph shows traffic for WAN and PoE. On the right, an 'Alert Message' popup window is open, displaying a list of events. The events are as follows:

Time	Status	Device Type	Information
10:05:00	Disconnect	Industrial Switch	IGS-5225-8P4S 192.168.1.180 a8:f7:e0:62:31:80
09:18:00	Connect	Industrial Switch	IGS-5225-8P4S 192.168.1.180 a8:f7:e0:62:31:80
09:18:00	Disconnect	Industrial Switch	IGS-5225-8P4S 192.168.1.180 a8:f7:e0:62:31:80

Red boxes and numbers 1 and 2 highlight the 'Message' icon at the bottom right of the dashboard and the 'X' close icon for an event in the popup window, respectively.

SYSTEM MENU - DOMAIN

Discovery



- ◆ Press the “Domain” icon (No. 1) , and then press Discovery (No. 2) and Search (No. 3) to find the managed APs and continue other settings.





39 0 0
Device(s) Client(s) Group(s)

Discovery Device List Topology View

Total: 4 Refresh Add All Filter by Content





Num.	MAC Address	Device Type	Model No.	Version	Device IP	Device Description	Support Authorization
1	00:30:4f:a0:00:88	Unknown	HDP-1261PT	2.12.44.12.7	192.168.100.78	PLANET HDP-1261PT	
2	a8:f7:e0:00:88:87	Media Converter	IGT-900-2T2S	v1.440b220912	192.168.100.47	IE Managed Converter	
3	00:30:4f:a0:00:44	Unknown	VTS-700WP	2.12.43.13.4	192.168.100.82	PLANET VTS-700WP	
4	a8:f7:e0:00:8b:11	Wireless	WDAP-W1800AXU	v1.2102b230519	192.168.100.77	Indoor 1800AX Wireless AP	
5	a8:f7:e0:90:bf:a5	Industrial Switch	BSP-360	v3.253b220526	192.168.100.195	BSP-360	

- **Support Authorization:** If the devices support MQTT protocol, the status will show “Blue Key”.

Key	Status
	Supported
	Not supported
	Managed by the other NMS

Adding Devices to List

- ◆ Select devices (No. 1) by checking the boxes, and then press the “Apply” icon (No. 2) to add devices to management list.

Discovery	Device List	Topology View	Total: 5						Refresh	Add	All	Filter by Content	Q
1	Num.	MAC Address	Device Type	Model No.	Version	Device IP	Device Description	Support Authorization					
<input checked="" type="checkbox"/>	1	00:30:4f:a0:00:88	Unknown	HDP-1261PT	2.12.44.12.7	192.168.100.78	PLANET HDP-1261PT						
<input checked="" type="checkbox"/>	2	a8:f7:e0:00:88:87	Media Converter	IGT-900-2T2S	v1.440b220912	192.168.100.47	IE Managed Converter						
<input checked="" type="checkbox"/>	3	00:30:4f:a0:00:44	Unknown	VTS-700WP	2.12.43.13.4	192.168.100.82	PLANET VTS-700WP						
<input checked="" type="checkbox"/>	4	a8:f7:e0:00:8b:11	Wireless	WDAP-W1800AXU	v1.2102b230519	192.168.100.77	Indoor 1800AX Wireless AP						
<input checked="" type="checkbox"/>	5	a8:f7:e0:90:bf:a5	Industrial Switch	BSP-360	v3.253b220526	192.168.100.195	BSP-360						

Manual Add Devices to List

- ◆ Press (No. 1) “+” button to manual add device and enter the devices info., then press the “Apply” icon (No. 2) to add devices to management list. **If the PLANET devices is in different sub-net or VLAN, it still works.**



Discovery | **Device List** | Topology View

Total: 39, Offline: 10, Online: 29

Status	Group	MAC Address	Device Type	Model No.	Version	IP Address	Device Description	Action
<input type="checkbox"/>		00:30:4f:bd:22:66	Camera	ICA-M3580P	N/A	192.168.100.114	ICA-M3580P	
<input type="checkbox"/>		00:55:b1:ff:8b:73	Switch	SGS-6310-24T4X	Version 100687	192.168.100.45	SGS-6310-24T4X	

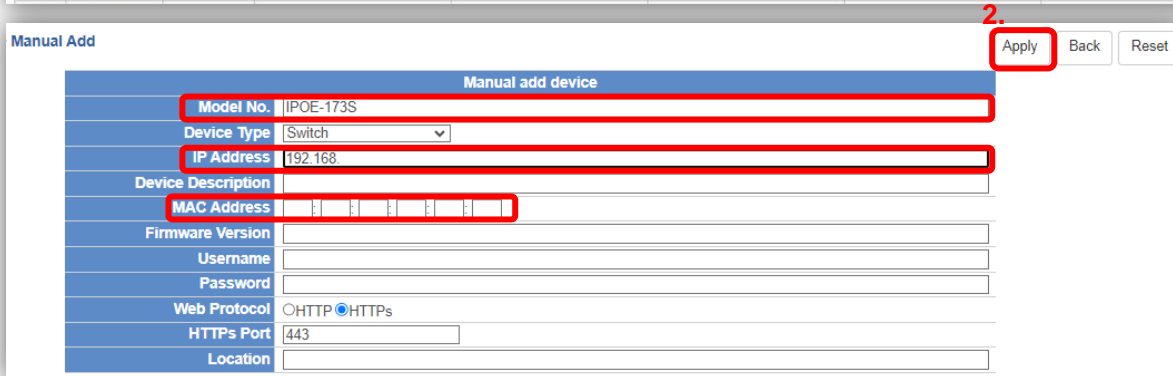

Manual Add

Manual add device

Model No. | IPOE-173S

Device Type | Switch

IP Address | 192.168.

Device Description

MAC Address

Firmware Version

Username

Password

Web Protocol | HTTP HTTPs

HTTPs Port | 443

Location

Apply | Back | Reset

- Required fields: Include **Model No., IP Address, MAC Address**
- Suggested input fields: **Firmware Version**

Device List and Topology View

- ◆ Press “Device List” to see the device status.
- ◆ Press “Topology View” to see the domain network topology after one minute.
- ✧ If you do not see the topology, please check devices to enable SNMP and LLDP function.

Discovery	Device List	Topology View	Total: 7, Online: 7				Filter by Content	🔍	🗑️	
☐	Status	Group	MAC Address	Device Type	Model No.	Version	IP Address	Device Description	Authorization Status	Action
<input type="checkbox"/>	🟢		00:30:4f:00:06:45	IP camera	ICA-3460V	N/A	192.168.1.177	PLANET	🔑🚫	🔍🔗🗑️
<input type="checkbox"/>	🟢		88:dc:96:56:7c:84	Wireless	WBS-502AC	1.0.0.11	192.168.1.172	WBS-502AC	🔑🚫	🔍🔗🗑️
<input type="checkbox"/>	🟢		8c:88:2b:00:00:46	Wireless	WNAP-W2201A	v1.3465cb170926	192.168.1.195	WNAP-W2201A	🔑🚫	🔍🔗🗑️
<input type="checkbox"/>	🟢		a8:f7:e0:55:41:7a	Wireless	WDAP-C7200E	WDAP-C7200E-AP-ETSI-V3.0-Build20200321131724	192.168.1.129	C7200E_2F	🔑🚫	🔍🔗🗑️
<input type="checkbox"/>	🟢		a8:f7:e0:60:2f:7b	Router	IVR-100	v1.1907b200428	192.168.1.1	PLANET IVR-100 VPN Gateway	🔑	🔍🔗🗑️
<input type="checkbox"/>	🟢		a8:f7:e0:62:31:80	Industrial Switch	IGS-5225-8P4S	v3.440b200331	192.168.1.180	IE L2+ Managed PoE+ Switch	🔑	🔍🔗🗑️
<input type="checkbox"/>	🟢		a8:f7:e0:65:e5:e1	Switch	GS-4210-8P2S	v2.305b200330	192.168.1.148	L2/L4 Managed PoE Switch	🔑	🔍🔗🗑️

➤ **Authorization Status:** If the devices support MQTT protocol and are managed currently with NMS, the authorization status will show “Green Key”.

Key	Status
🔑	Managed
🔑🚫	Not supported
🔑⚠️	Managed Fail
🔑	Managed by the other NMS

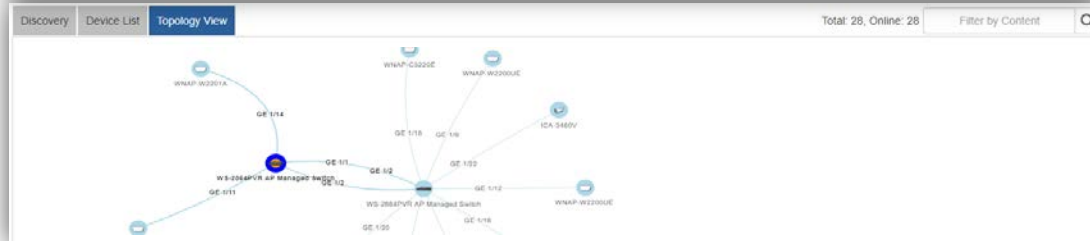

Device Identification

- ◆ Press the “Identification” icon to modify the device description, type, and devices’ detailed information.

Discovery	Device List	Topology View	Total: 39, Offline: 10, Online: 29							All	Filter by Content
	Status	Group	MAC Address	Device Type	Model No.	Version	IP Address	Device Description	Action		
<input type="checkbox"/>			00:30:4f:bc:a5:cb	VoIP	ICF-1800	14.0.1.4.r1	192.168.100.74	ICF-1800			
<input type="checkbox"/>			00:30:4f:bd:22:66	Camera	ICA-M3580P	N/A	192.168.100.114	ICA-M3580P			
<input type="checkbox"/>			00:55:b1:ff:8b:73	Switch	SGS-6310-24T4X	Version 100687	192.168.100.45	SGS-6310-24T4X			
<input type="checkbox"/>			64:9d:99:11:68:34	Switch	SGS-5240-24T4X	1.2.0	192.168.100.46	SGS-5240-24T4X			

Home > Site > Management > Identification

Apply Back Reset

Identification	
Device Description	ICF-1800
Device Type	VoIP
Username	
Password	
Web Protocol	<input type="radio"/> HTTP <input checked="" type="radio"/> HTTPS
HTTPS Port	443
Location	

Diagnostic Device Function















Diagnostic Device Function Button: If the devices support SNMP protocol and cannot respond to the broadcast requirement, press this button to change the NMS function by unicast.

Remarks: Executing this function will increase the CPU loading of NMS.

Device Information

Device Information

- ◆ Press the “Device Information” icon to use the virtual panel function of the switch.

		a8:f7:e0:6f:7e:ad	Switch	GS-6320-24UP2T2XV	v2.2112b230704	192.168.100.10	GS-6320-24UP2T2X(v2)				
		a8:f7:e0:74:44:91	Industrial Switch	IGS-5225-8P2S2X	v3.440b230619	192.168.203.12	IGS-5225-8P2S2X				
		a8:f7:e0:88:00:23	Industrial Switch	IGS-6325-8UP2S2X	v2.2112b230807	192.168.201.33	IGS-6325-8UP2S2X(v2)				

GS-6320-24UP2T2XV  Uptime: 16 days 7 hours 33 minutes 9 seconds

- GS-6320-24UP2T2XV 



System Traffic PoE Port Save Configuration

PoE Usage: **8.6W**

ERPS: OFF STP: OFF

LLDP: ON

SNMP: ON

Uplink Port: 25, 26 

Data Rate:  1.52 KB

 12.61 KB

Device Type: Switch IP Address: 192.168.100.10 

Firmware Version: v2.2112b230704 Subnet Mask: 255.255.255.0

MAC Address: a8:f7:e0:6f:7e:ad Gateway: 192.168.100.1

- Virtual panel function : On this page, can monitor and control the switch.

Device Information - Virtual Panel

GS-6320-24UP2T2XV ● 

Uptime: 16 days 7 hours 33 minutes 9 seconds

- GS-6320-24UP2T2XV T



GS-6320-24UP2T2XV ● 

- GS-6320-24UP2T2XV T

Edit

Configuration of System Description

System Description

➤ **Edit:** Configure the Switch System Name in SNMP.

System Information Configuration

System Contact	Default Contact
System Name	GS-6320-24UP2T2XV
System Location	Default Location

Device Information - System



The screenshot shows the 'System' configuration page of a PLANET switch. At the top, there are tabs for 'System', 'Traffic', 'PoE', and 'Port'. A 'Save Configuration' button is located in the top right corner. The 'PoE Usage' section features a circular gauge displaying '8.6W'. To the right of the gauge, there are four settings: 'ERPS: OFF', 'LLDP: ON', 'SNMP: ON', and 'STP: OFF'. Each setting is accompanied by a toggle switch.

- **PoE Usage:** Show **total** PoE usage power
- **ERPS:** Show ERPS Ring status.
- **LLDP:** On/Off LLDP function
- **SNMP:** On/Off SNMP function
- **STP:** On/Off STP function
- **Save Configuration:** After configuring the switch, press the button to finish the save configuration.



Device Information - System

Uplink Port: 25, 26 Data Rate: ↓ 1.52 KB ↑ 12.61 KB	Device Type: Switch Firmware Version: v2.2112b230704 MAC Address: a8:f7:e0:6f:7e:ad	IP Address: 192.168.100.10 Subnet Mask: 255.255.255.0 Gateway: 192.168.100.1
---	--	---

➤ **Uplink Port:** To configure the Uplink Port by edit icon.

➤ **LAN Configuration:** To configure LAN IP, subnet mask, and default gateway by edit icon.

Uplink Port: 25, 26
Data Rate: ↓ 1.52 KB
↑ 12.61 KB

Data Rate: Show

Uplink port upload & download traffic.

Edit

Uplink Configuration	
Port	Port 19 Port 20 Port 21 Port 22 Port 23 Port 24 Port 25 Port 26 Port 27

Press keyboard "Ctrl" to do multi-selections.

LAN Configuration

LAN Configuration	
IP Address	<input type="text" value="192.168.100.10"/>
Netmask	<input type="text" value="255.255.255.0"/>
Gateway	<input type="text" value="192.168.100.1"/>

Device Information - Traffic

- **Traffic:** On this page, you can see the traffic history graph of TX/RX on uplink port by selecting hour, day, week or month.

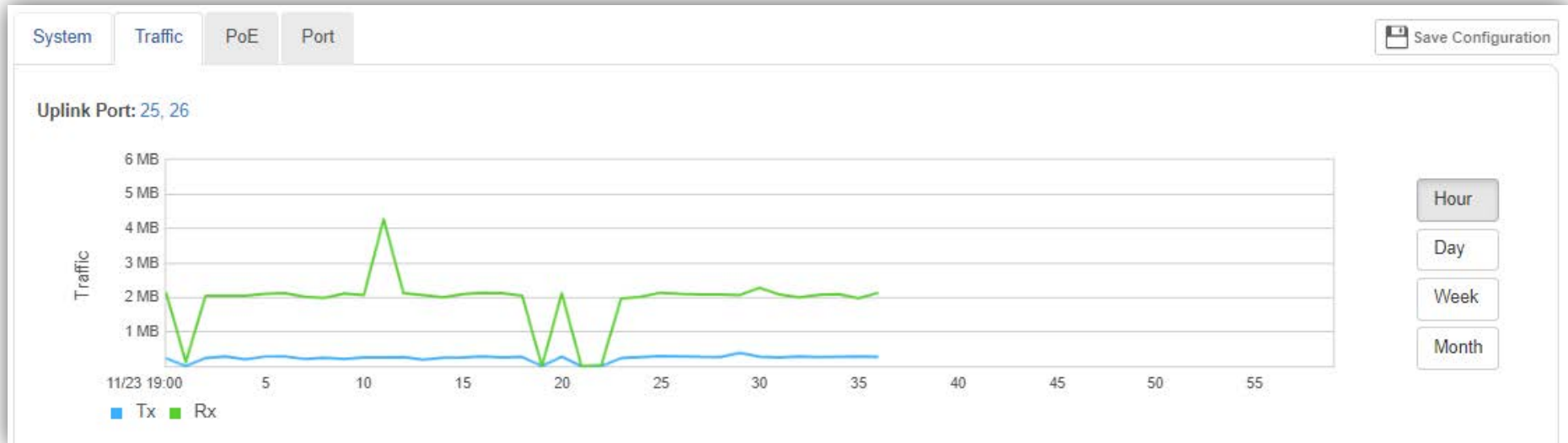

Device Information - PoE



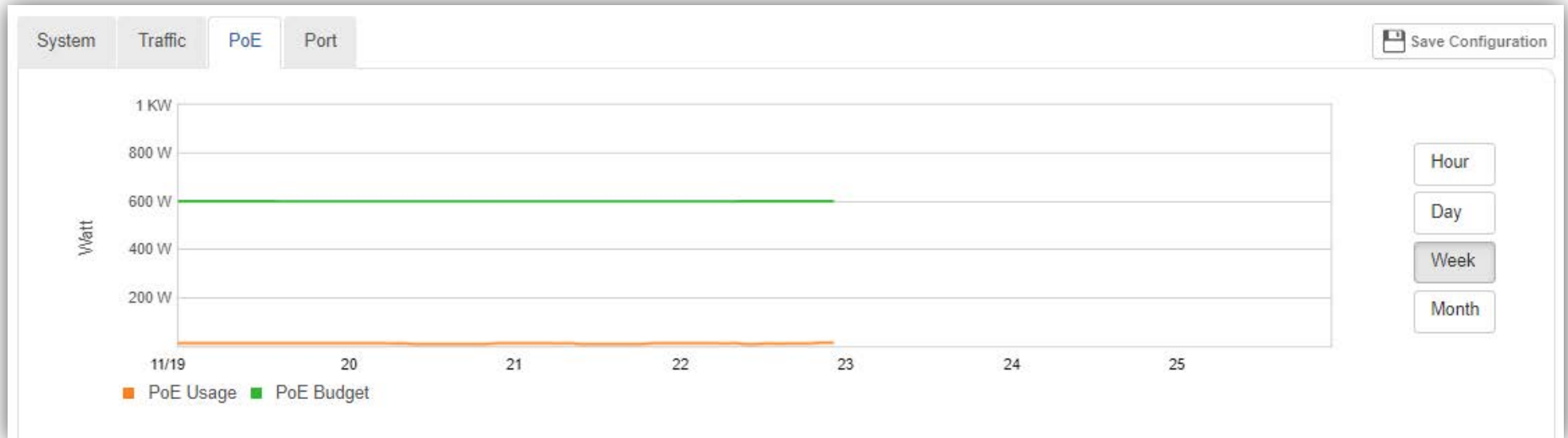











- **PoE:** On this page, you can see the total PoE history graph of PoE usage/PoE Budget by selecting hour, day, week or month.



Device Information - Port

➤ **Port:** On this page, you can manage each port on the switch.

System
Traffic
PoE
Port
Save Configuration

	Port 1: <input type="text" value="SGS-6310-24T4X"/> <input type="button" value="T"/>	VLAN:1	Mode: Access	Speed:1G	PVID:1	
<input checked="" type="checkbox"/>	Traffic: ↓ 0 B ↑ 4.64 KB	PoE: <input type="text"/>	0W/95W (0%)	<input type="button" value="PD Alive Check"/> : Disable		
	Port 2: <input type="text" value="WGS-5225-8T2SV_Flat"/> <input type="button" value="T"/>	VLAN:1	Mode: Access	Speed:1G	PVID:1	
<input checked="" type="checkbox"/>	Traffic: ↓ 0 B ↑ 4.64 KB	PoE: <input type="text"/>	0W/95W (0%)	<input type="button" value="PD Alive Check"/> : Disable		
	Port 3: <input type="text" value="WGS-5225-8P2SV_Flat"/> <input type="button" value="T"/>	VLAN:1	Mode: Access	Speed:1G	PVID:1	
<input checked="" type="checkbox"/>	Traffic: ↓ 102 B ↑ 4.75 KB	PoE: <input type="text"/>	0W/95W (0%)	<input type="button" value="PD Alive Check"/> : Disable		
	Port 4: <input type="text"/> <input type="button" value="T"/>	VLAN:204	Mode: Access	Speed:UNDEFINED	PVID:204	
<input checked="" type="checkbox"/>	Traffic: ↓ 0 B ↑ 0 B	PoE: <input type="text"/>	0W/95W (0%)	<input type="button" value="PD Alive Check"/> : Disable		
	Port 5: <input type="text"/> <input type="button" value="T"/>	VLAN:1	Mode: Access	Speed:UNDEFINED	PVID:1	
<input checked="" type="checkbox"/>	Traffic: ↓ 0 B ↑ 0 B	PoE: <input type="text"/>	0W/95W (0%)	<input type="button" value="PD Alive Check"/> : Disable		
	Port 6: <input type="text" value="IGT-900-2T2S"/> <input type="button" value="T"/>	VLAN:1	Mode: Access	Speed:1G	PVID:1	
<input checked="" type="checkbox"/>	Traffic: ↓ 0 B ↑ 4.64 KB	PoE: <input type="text"/>	0W/95W (0%)	<input type="button" value="PD Alive Check"/> : Disable		
	Port 7: <input type="text" value="A10"/> <input type="button" value="T"/>	VLAN:1	Mode: Access	Speed:100M	PVID:1	
<input checked="" type="checkbox"/>	Traffic: ↓ 0 B ↑ 4.64 KB	PoE: <input type="text" value="1.3W/95W (1%)"/>	<input type="button" value="PD Alive Check"/> : Disable			

Device Information - Port



Port 1: [T] VLAN: 1,2,4 Mode: Hybrid Speed: 10/100 PVID: 1

Traffic: ↓ 80 Mbps ↑ 30 Mbps PoE: 15W/30W (50%) PD Alive Check: Enable



- Shows per port connection status, port disable, or PoE in use.
- Press the On/Off button to enable/disable port.

 Disconnected

 Connected

 PoE in use

 Port function disabled

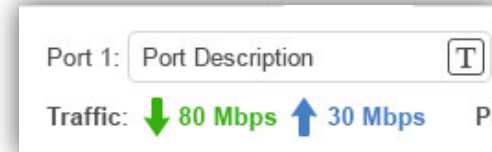

Port 1: [T]

Traffic: ↓ 80 Mbps ↑ 30 Mbps PoE: 15W/30W (50%)

- Port description edit by "T" icon.
- Port download & upload traffic.



VLAN: 1,2,4 Mode: Hybrid Speed: 10/100 PVID: 1

- Shows Port VLAN, Mode, Link Speed and PVID info.

Device Information - Port



 Port 1: VLAN: 1,2,4 Mode: Hybrid Speed: 10/100 PVID: 1

ON Traffic: ↓ 80 Mbps ↑ 30 Mbps PoE: 15W/30W (50%) PD Alive Check: Enable

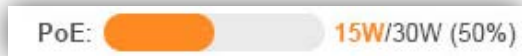

PoE: 15W/30W (50%)

➤ Shows Port PoE usage, budget or health (%)



PD Alive Check: Enable

➤ Shows Port PD alive check status.

➤ Press icon to show port traffic and PoE history graph.

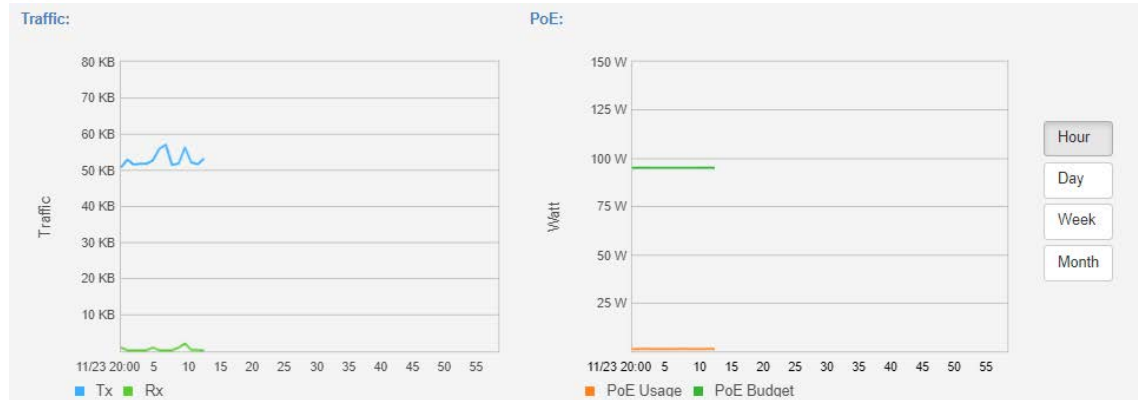

➤ Get IP camera snapshot via switch ONVIF function.

SYSTEM MENU - AP CONTROL

AP Control UI – Structure & Description

AP control icon

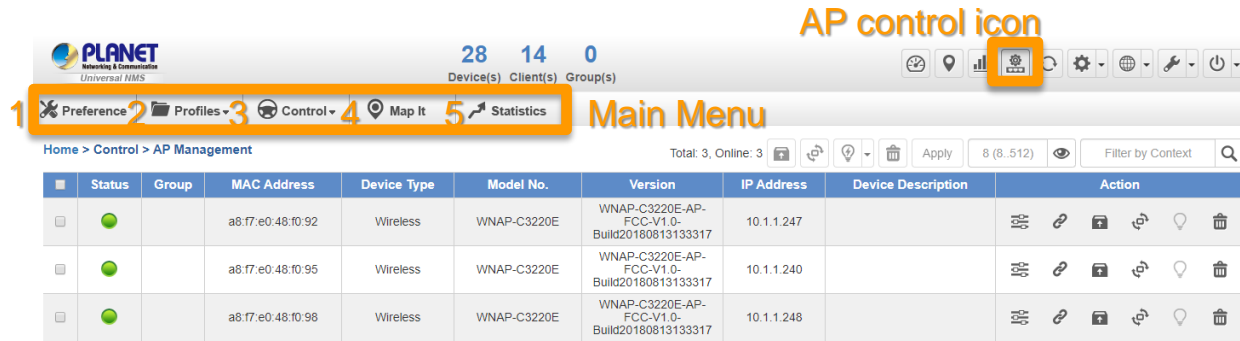

28 14 0
Device(s) Client(s) Group(s)

1 Preference 2 Profiles 3 Control 4 Map It 5 Statistics Main Menu

Home > Control > AP Management Total: 3, Online: 3 Apply 8 (8.512) Filter by Context

Item	Status	Group	MAC Address	Device Type	Model No.	Version	IP Address	Device Description	Action
	●		a8:f7:e0:48:10:92	Wireless	WNAP-C3220E	WNAP-C3220E-AP-FCC-V1.0-Build20180813133317	10.1.1.247		[Icons]
	●		a8:f7:e0:48:10:95	Wireless	WNAP-C3220E	WNAP-C3220E-AP-FCC-V1.0-Build20180813133317	10.1.1.240		[Icons]
	●		a8:f7:e0:48:10:98	Wireless	WNAP-C3220E	WNAP-C3220E-AP-FCC-V1.0-Build20180813133317	10.1.1.248		[Icons]

Item	Description	Remarks
1	Preference	Edit region, RO community, RW community
2	Profiles	Set up SSID, Radio (2.4G, 5G) Profiles
3	Control	AP and AP group management
4	Map It	Edit the map of AP location and coverage
5	Statistics	Show the statuses of managed APs and active clients

Main Menu – Preference

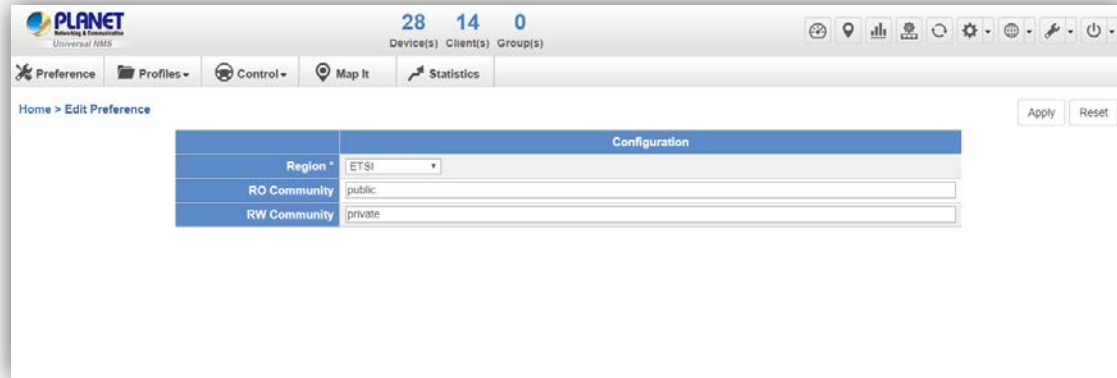

[Preference]





















- **Preference:** On this page, you can choose the device region of FCC or ETSI.
- Then edit **SNMP RO community and RW community** for public or private use. **(Set up for all devices, not only for APs)**
- Select Apply or Reset.
- Noted: Device of FCC and device of ETIS cannot be shown at the same time.

Main Menu – Profiles

Preference Search Profiles Control Map It Statistics

Home > SSID Profile > SSID

Filter by SSID Name 10 (10..128)

Num.	Model No.	SSID Name	SSID Broadcast	Security	Encryption	Client Isolation	Action
1	WBS-502N	6F Customer	Enabled	WPA-Mixed	Personal (Pre-Shared Key)	Enabled	 
2	WBS-502N	Btest 502N	Enabled	WPA2	Personal (Pre-Shared Key)	Disabled	 
3	WBS-502N	PLANET 7F	Enabled	WPA-EAP	Enterprise (RADIUS)	Enabled	 
4	WBS-502N	Test 502N	Enabled	WPA	Personal (Pre-Shared Key)	Enabled	 
5	WNAP-C3220A	3F_C3220A	Enabled	WPA2	Personal (Pre-Shared Key)	Enabled	 
6	WNAP-C3220A	Test C3220A	Enabled	Disable	Disabled	Disabled	 
7	WNAP-C3220E	Test C3220E	Enabled	WPA-EAP	Enterprise (RADIUS)	Disabled	 
8	WNAP-W2200UE	1F_W2200UE	Enabled	WPA	Personal (Pre-Shared Key)	Disabled	 
9	WNAP-W2200UE	PLANET 7F	Enabled	WPA2	Personal (Pre-Shared Key)	Enabled	 
10	WNAP-W2200UE	Test W2200UE	Enabled	WPA2	Personal (Pre-Shared Key)	Enabled	 

Total Profile: 10

[Profiles]

- **Profiles:** On this page, you can create the SSID and 2.4GHz/5GHz profiles for further AP provisioning.
- **SSID Profiles:** Click the “Add new profile” button to add a new SSID profile.
- **Radio Profiles:** Click the “Add new profile” button to add a new 2.4GHz radio profile or 5GHz radio profile.
- You can create up to 32 profiles for each type of profiles (SSID, 2.4G radio, 5G radio).

Main Menu – Profiles

Preference Search Profiles Control Map It Statistics

Home > SSID Profile > Configuration Apply Back Reset

SSID Profile Configuration

Model No. WBS-502N

SSID Configuration

SSID Name PLANET 7F

Hide SSID

Client Isolation Enable

VLAN ID 4094 (3 to 4094)

Security Configuration

Encryption WPA-EAP





Authentication Mode Enterprise (RADIUS)

RADIUS Server IP Address 1.1.1.1

RADIUS Server Port 1

RADIUS Server Password 7777

[SSID Profile Configuration]

- On the SSID profile configuration page, enter the value that you preferred and then click “Apply” to save the profile.
-  Add new profile: Click it to add a new profile.
-  Delete selected item: Click it to delete the selected profile.
-  Edit: Click it to edit the profile.
-  Delete: Click it to delete the single profile.
- Filter: You can filter the search result by entering the keywords in the field next to the magnifier icon. The keywords include: SSID Name

Main Menu – 3/Profiles

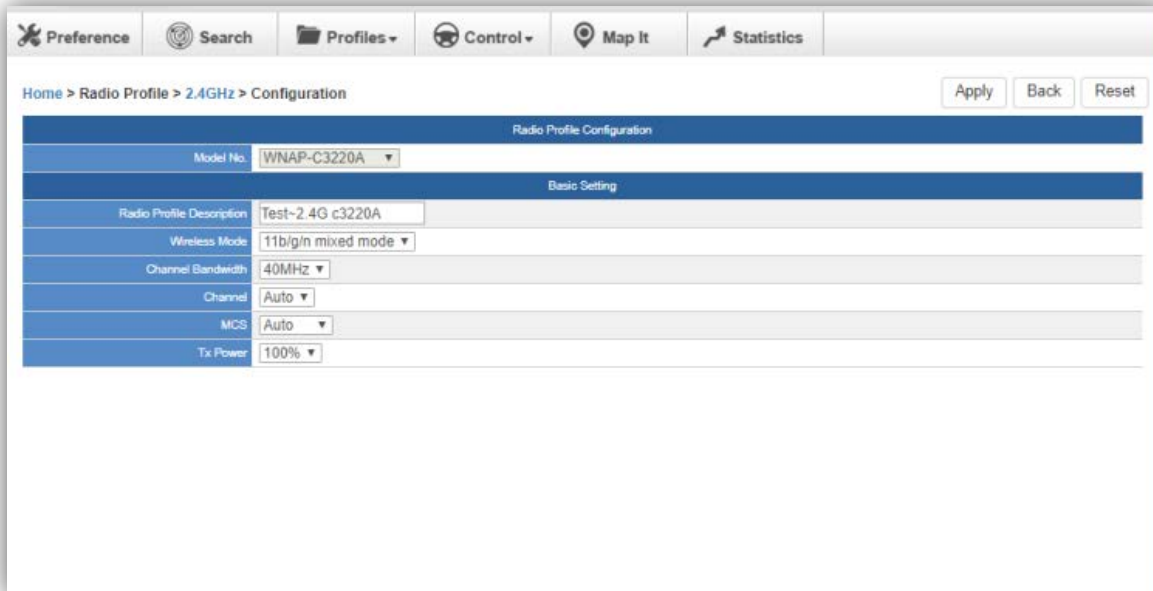

Preference Search Profiles Control Map It Statistics

Home > Radio Profile > 2.4GHz > Configuration Apply Back Reset

Radio Profile Configuration

Model No. WNAP-C3220A

Basic Setting

Radio Profile Description	Test-2.4G c3220A
Wireless Mode	11b/g/n mixed mode
Channel Bandwidth	40MHz
Channel	Auto
MCS	Auto
Tx Power	100%

- On the Radio profile configuration page, enter the value that you preferred and then click “Apply” to save the profile.
- Apply: Click this button to save the settings.
- Back: Click this button to return to the previous page.
- Reset: Click this button to reset all fields to default value.

[2.4GHz Radio Profile Configuration]

Main Menu – 3/Profiles

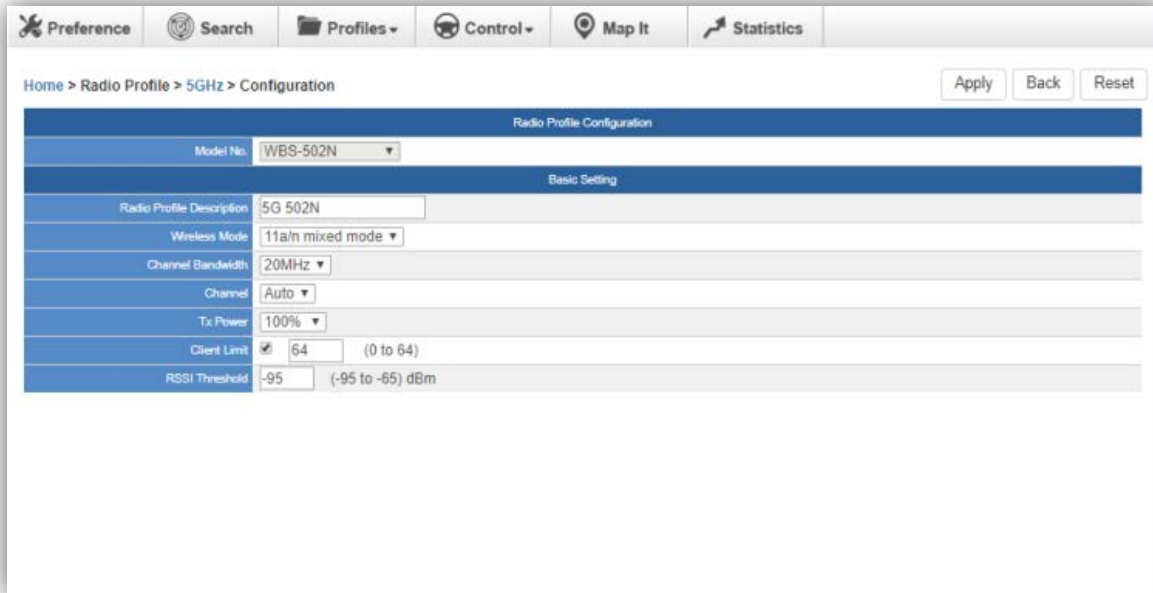

Radio Profile Configuration	
Model No.	WBS-502N

Basic Setting	
Radio Profile Description	5G 502N
Wireless Mode	11a/n mixed mode
Channel Bandwidth	20MHz
Channel	Auto
Tx Power	100%
Client Limit	<input checked="" type="checkbox"/> 64 (0 to 64)
RSSI Threshold	-95 (-95 to -65) dBm

Remarks:

1. Strongly suggest you to keep the values as default except the fields like Channel, Network Mode, Channel Bandwidth, Tx Power, IAPP, and Tx/Rx to prevent any unexpected error or impact on the performance.
2. WMM Capable is not allowed to be disabled.

[5GHz Radio Profile Configuration]

Main Menu – Control

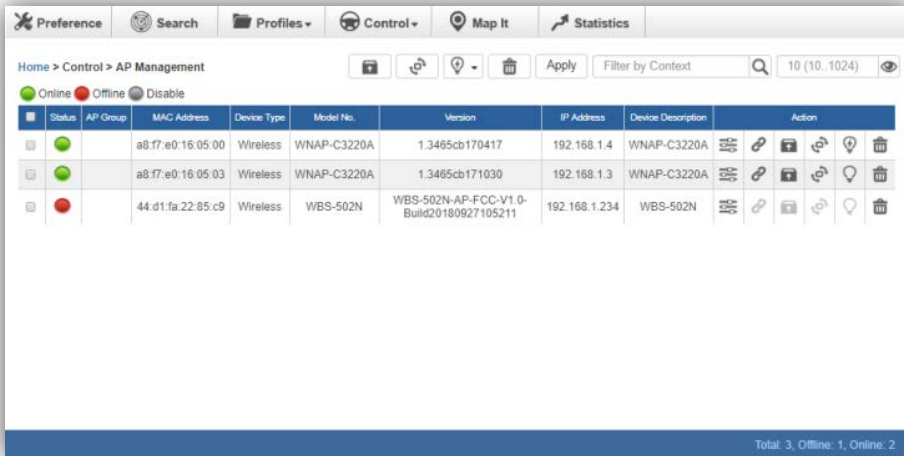

Home > Control > AP Management

Filter by Context: 10 (10.1024)

Legend: Online (Green), Offline (Red), Disable (Grey)

Status	AP Group	MAC Address	Device Type	Model No.	Version	IP Address	Device Description	Action
Online		a8:17:e0:16:05:00	Wireless	WNAP-C3220A	1.3465cb170417	192.168.1.4	WNAP-C3220A	[Icons]
Online		a8:17:e0:16:05:03	Wireless	WNAP-C3220A	1.3465cb171030	192.168.1.3	WNAP-C3220A	[Icons]
Offline		44:d1:fa:22:85:c9	Wireless	WBS-502N	WBS-502N-AP-FCC-V1.0-Build20180927105211	192.168.1.234	WBS-502N	[Icons]

Total: 3, Offline: 1, Online: 2

[Control - AP Management]

- **Control:** On this page, the system allows you to control the AP or AP group with specific actions.
- **AP Management:** Go to this page to control single AP or multiple APs.
- **AP Group Management:** Go to this page to create multiple APs as a group or control AP group.
- **Filter:** You can filter the AP list by entering the keyword in the field next to the magnifier icon. The keyword should be in any context that belongs to the fields like AP Group, MAC Address, Model, Version, IP Address, and Name.
- **Apply:** Click this button to apply the setting. The profile setting will not take effect until you click the “Apply” button on the Control’s main page.

Main Menu – Control

➤ Status:

 Connection status: online, offline, Wi-Fi disabled

 In progress: action in progress

 Finished/Successful: action finished and successful.

 Failed: action failed.

➤ Remarks:

To configure multiple APs at one time, select multiple APs and then choose one of the action icons on the top of the page.

The "Link" action is not allowed for multiple APs.

➤ Action:

 Setting: edit setting and allocate profile to AP

 Link: link to the AP's web page

 Firmware Update: Upgrade AP's firmware

 Reboot: Reboot the AP

 Delete: Delete the AP from the control list

 LED Control: Control the AP's LED.

Mouse-click in a sequential order:

LED blink-> LED off-> LED on

Main Menu – Control

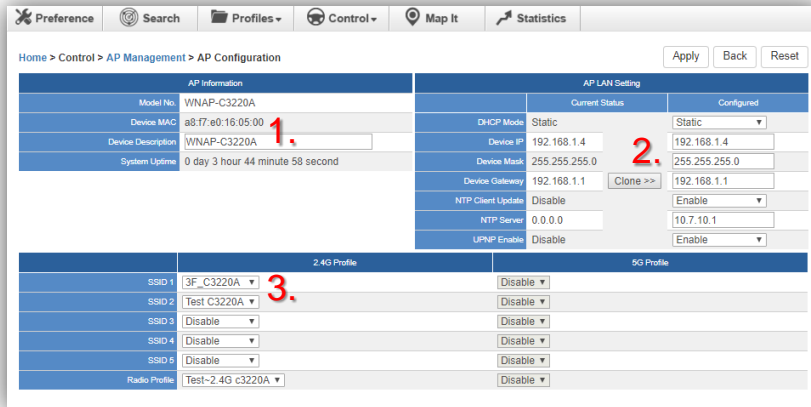

Home > Control > AP Management > AP Configuration

Apply Back Reset

AP Information		AP LAN Setting	
Model No:	WNAP-C3220A	DHCP Mode:	Static
Device MAC:	a8:f7:e0:16:05:00 1.	Current Status:	Configured
Device Description:	WNAP-C3220A	Device IP:	192.168.1.4
System Uptime:	0 day 3 hour 44 minute 58 second	Device Mask:	255.255.255.0 2.
		Device Gateway:	192.168.1.1
		NTP Client Update:	Disable
		NTP Server:	0.0.0.0
		UPNP Enable:	Disable
			Clone >>
			192.168.1.1
			Enable
			10.7.10.1
			Enable

2.4G Profile		5G Profile	
SSID 1:	3F_C3220A 3.	Disable	
SSID 2:	Test C3220A	Disable	
SSID 3:	Disable	Disable	
SSID 4:	Disable	Disable	
SSID 5:	Disable	Disable	
Radio Profile:	Test-2.4G c3220A	Disable	

➤ Procedure of configuring AP's setting:









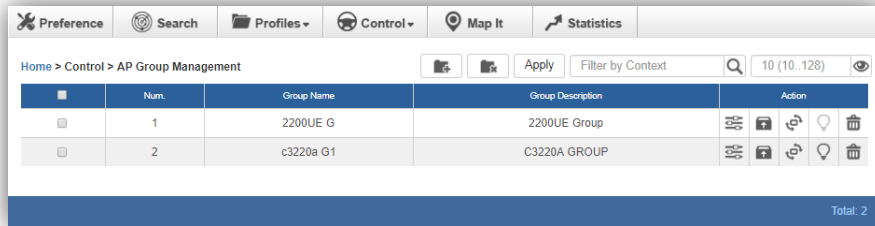

1. Edit the basic AP Information.
2. Click the “Clone >>” button if you want to use the same IP configuration as the previous LAN settings. Otherwise, please enter the preferred LAN setting.
3. If there are already profiles created, you can designate the SSID profile and Radio profile to this AP. You can do this step later once AP's basic setting is done

[AP Configuration]

- On the AP Group Configuration page, you can create an AP group with the same model of AP.
- Save: Click this button to save the group/setting.
- Back: Click this button to return to the previous page.
- Reset: Click this button to reset all fields to default value.
- Remarks: The system allows to create up to 32 AP groups.

Main Menu – Control



	Num.	Group Name	Group Description	Action
<input type="checkbox"/>	1	2200UE G	2200UE Group	    
<input type="checkbox"/>	2	c3220a G1	C3220A GROUP	    



Total: 2

[3/Control - AP Group Management]

➤ Remarks:

To do profile provisioning to multiple AP groups at one time, select multiple AP groups, and then click the “Apply” button.

The "Link" action is not allowed for multiple APs or AP group.

- On the AP Group Management page, you can create AP group and control one or more AP groups.
-  Add new group: Click it to add an AP group.
-  Delete selected item: Click it to delete the selected AP group.
- Apply: Click this button to apply the setting. The profile setting will not take effect to a group until you click the “Apply” button.

Main Menu – Control

Home > Control > AP Management

Online Offline Disable

Status	AP Group	MAC Address	Model	Version	IP Address	Name	Action
		a8:f7:e0:1e:1f:dd	WDAP-W7200AC	tfp-170406	192.168.0.119	Wi-Fi_11ac_AP	
		a8:f7:e0:16:05:09	WNAP-W2201A	1.3465cb170407	192.168.0.101	WNAP-W2201A	
		a8:f7:e0:1e:1f:d1	WDAP-W7200AC	tfp-170406	192.168.0.105	Wi-Fi_11ac_AP	
	Ceiling-mount_1	a8:f7:e0:00:01:00	WNAP-C3220A	1.3465cb170406	192.168.0.102	WNAP-C3220A	
	Ceiling-mount_1	a8:f7:e0:16:05:00	WNAP-C3220A	1.3465cb170406	192.168.0.103	WNAP-C3220A	

➤ Procedure of profile provisioning to AP groups:

1. Select the AP group.
2. Click the “Apply” button.
3. Go to “3/Control-> AP Management” to check whether the status is becoming “In progress”. Wait until the status comes “Online”.

➤ Action:

- Setting: Edit setting and allocate profile to group
- Firmware Update: Upgrade AP group’s firmware
- Reboot: Reboot the AP group
- Delete: Delete the AP group from the control list
- LED Control: Control the AP group’s LED.

Mouse-click in a sequential order:

LED blink-> LED off-> LED on

Main Menu – Map It



[Map It]

- **Map It:** On this page, the system allows you to upload your floor map to the system and you can add managed APs to the actual position against the floor map. This is convenient to user to view and adjust the actual deployment by reference to its real transmission power and channel allocation.
- The system allows user to upload up to 10 floor maps.

*Please use mouse to use this function.

- A system message will prompt to remind you to edit map first if there is no other map available in the system. Click “OK” to continue.

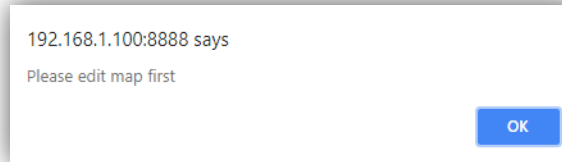

- On the Edit Map page, click “Choose File” and enter the map’s description. Then click “Apply” to upload the map.



Main Menu – Map It

- After finishing map uploading, you can click the sidebar at the left-side of the window to expand the AP list.

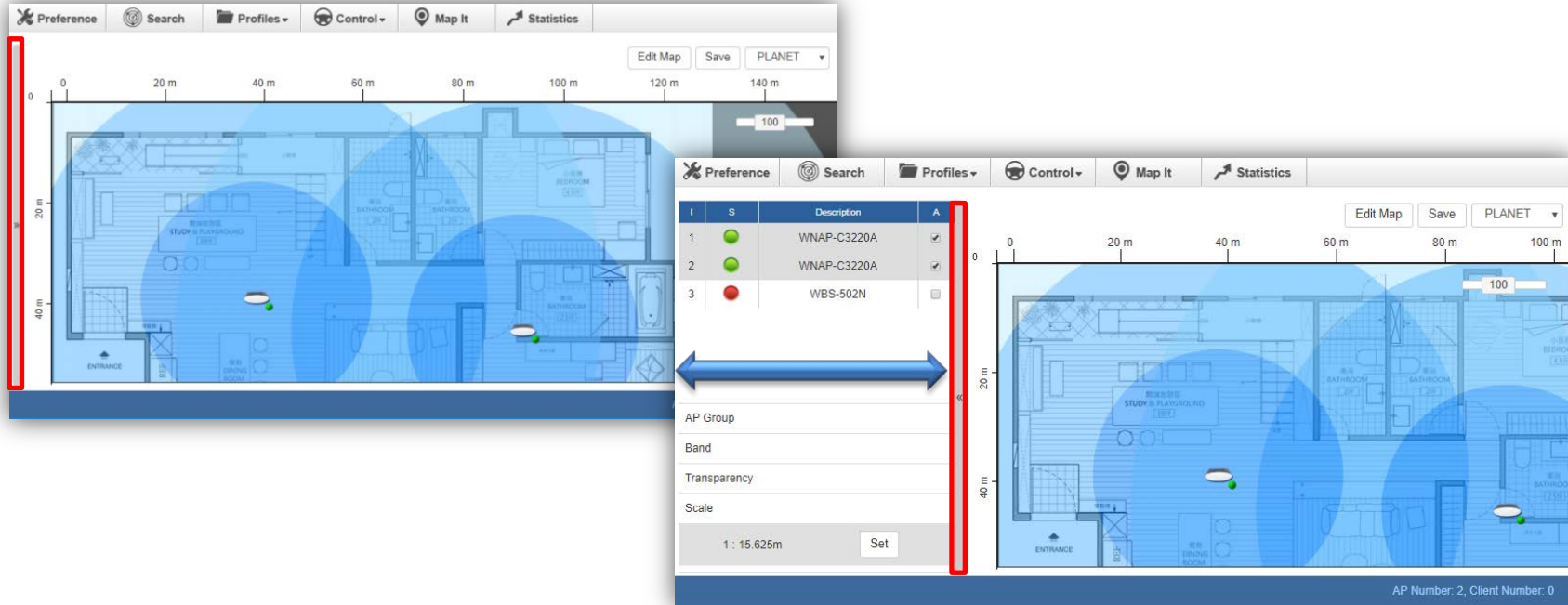

The screenshot displays the PLANET software interface in the 'Map It' view. The main window shows a floor plan with blue circular signal coverage areas for three Access Points (APs). A sidebar on the left is expanded to show a list of APs, with a red vertical bar highlighting the list area. A blue double-headed arrow points from the sidebar to the map area, indicating the interaction.

I	S	Description	A
1	●	WNAP-C3220A	<input checked="" type="checkbox"/>
2	●	WNAP-C3220A	<input checked="" type="checkbox"/>
3	●	WBS-502N	<input type="checkbox"/>

Below the table, the sidebar contains the following settings:

- AP Group
- Band
- Transparency
- Scale: 1 : 15.625m
- Set

The main map window includes a toolbar with 'Preference', 'Search', 'Profiles', 'Control', 'Map It', and 'Statistics'. The map itself has a scale bar from 0 to 140m and a zoom level of 100. The status bar at the bottom right indicates 'AP Number: 2, Client Number: 0'.

Main Menu – Map It

- Setting Scale: 1. Click “Scale” to start to reset the map scale.

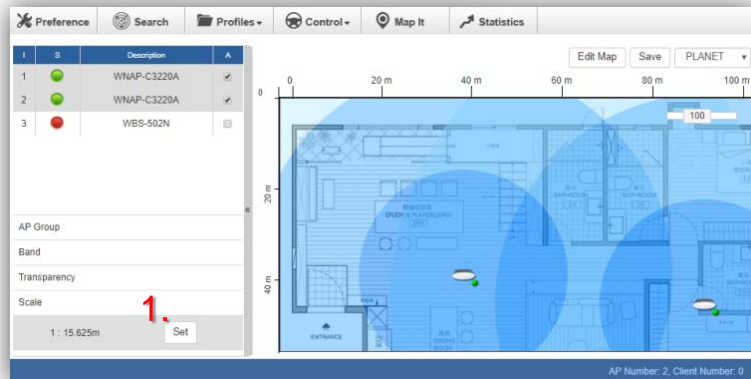

- Press the “Set” button to draw a line on the map. Fill its physical distance in the blank and press “Set” or “Cancel”. For example, in the graph below, set the door width to 0.8 m.

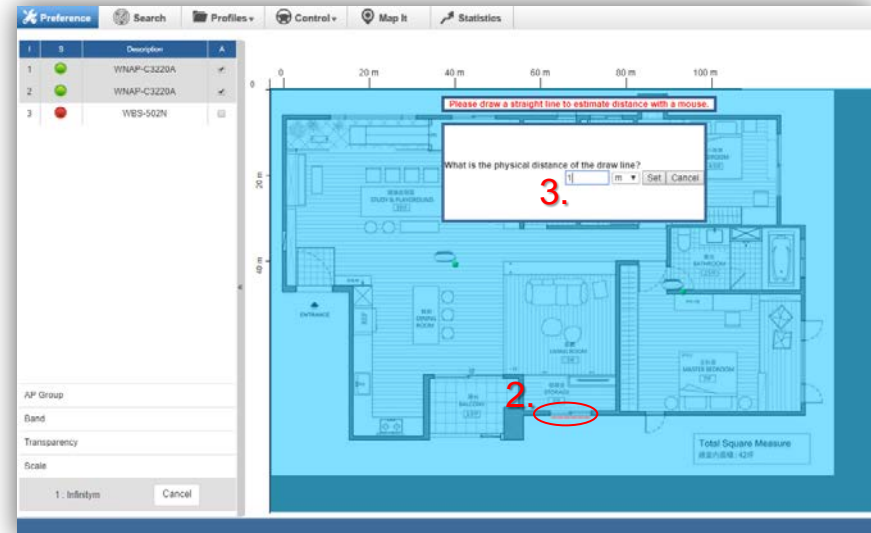

Main Menu – Map It

- Drag and drop the AP onto the map or select multiple APs by clicking the checkbox.



- Once the allocation is done, click “Save” to save the setting.

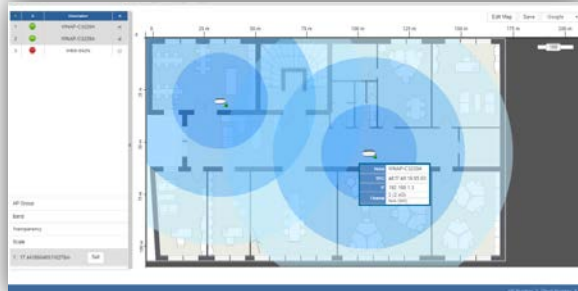
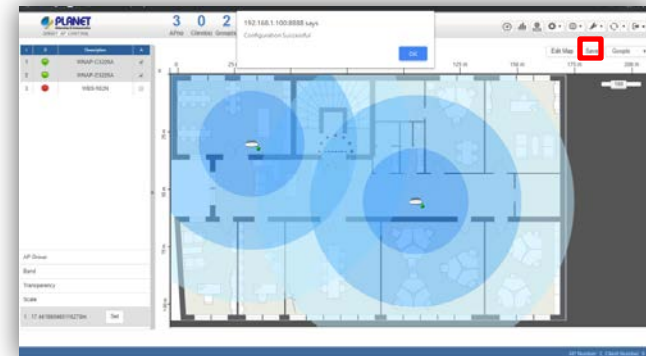

- To upload more maps or edit current map, click the “Edit Map” button to re-enter the Edit Map page.

Main Menu – Map It

- The lower-left side area provides map control options.
- AP Group: To filter the managed APs shown on the map, the selected AP group is displayed.

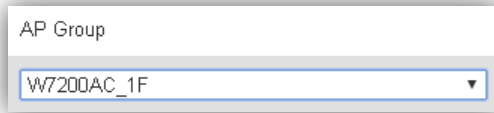

- Band: Select “2.4GHz” to show APs with 2.4GHz frequency or select “5GHz” to show APs with 5GHz frequency.

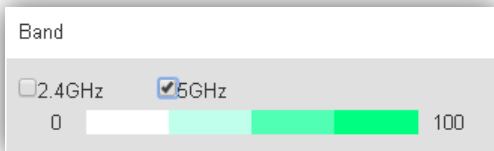
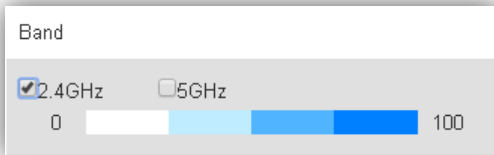

- Transparency: Slide the bar to adjust the transparency of the map.

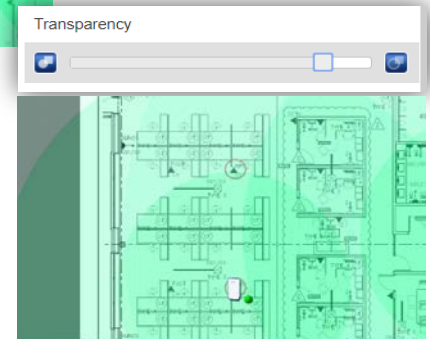
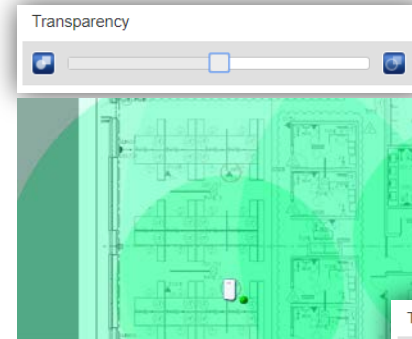

Main Menu – Statistics

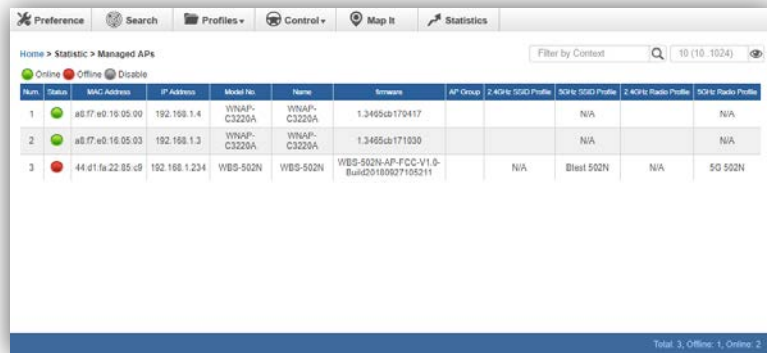

Home > Statistic > Managed APs

Filter by Context: 10 (10, 1024)

Num.	Status	MAC Address	IP Address	Model No.	Name	Firmware	AP Group	2.4GHz SSID Profile	5GHz SSID Profile	2.4GHz Radio Profile	5GHz Radio Profile
1	Online	a8:f7:e0:16:05:00	192.168.1.4	WNAP-C3220A	WNAP-C3220A	1.3465cb170417			N/A		N/A
2	Online	a8:f7:e0:16:05:03	192.168.1.3	WNAP-C3220A	WNAP-C3220A	1.3465cb171030			N/A		N/A
3	Offline	44:d1:fa:22:85:c9	192.168.1.234	WBS-502N	WBS-502N	WBS-502N-AP-FCC-V1.0-Build20180927105211		N/A	Best 502N	N/A	SG 502N

Total: 3, Online: 1, Offline: 2

[Statistics – Managed APs]

- Managed APs: On this page, you can observe the current configuration of all managed APs.
- Filter: You can filter the AP list by entering the keyword in the field next to the magnifier icon. The keyword should be in any context that belongs to the fields of this page.

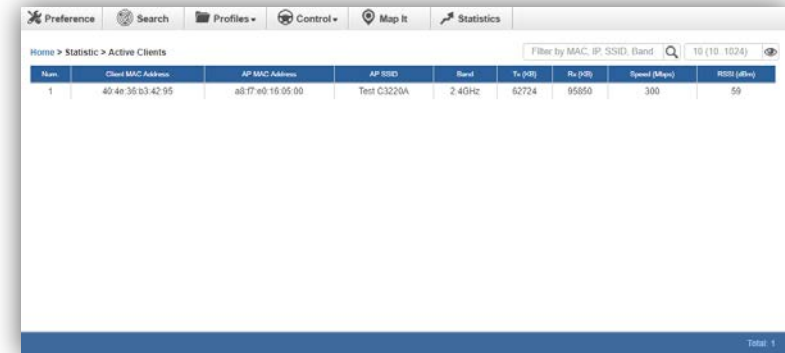

Home > Statistic > Active Clients

Filter by MAC, IP, SSID, Band: 10 (10, 1024)

Num.	Client MAC Address	AP MAC Address	AP SSID	Band	Tx (KB)	Rx (KB)	Speed (Mbps)	RSSI (dBm)
1	40:4b:36:b3:42:95	a8:f7:e0:16:05:00	Test C3220A	2.4GHz	62724	95650	300	59

Total: 1

[Statistics – Active Clients]

- Active Clients: On this page, you can observe the statuses of all associated clients including traffic statistics, transmission speed and RSSI signal strength.
- Filter: You can filter the search result by entering the keywords in the field next to the magnifier icon. The keywords include MAC Address, IP Address, SSID and Band.

SYSTEM MENU – REFRESH

System Menu – Refresh



[System Menu – Refresh]

- **Refresh:** The page content will be updated every 1 minute automatically by default. If you require the system to update immediately, you may click “Manually” to refresh the page content.

SYSTEM MENU - SYSTEM CONFIGURATION

System Menu – System Configuration

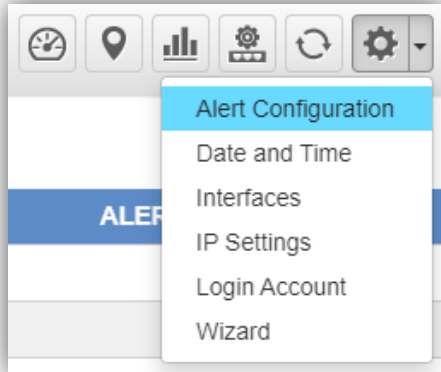

[System Menu – System Configuration]

- **Alert Configuration:** On this page, you can configure the system event notice enable or disable by Popup Alert Message and SMTP function.
- After configuration is done, click “Apply” to apply the setting.

Home > Alert Configuration Apply Reset

	ENABLE	ALERT_MESSAGE	SMTP
System Start	<input checked="" type="checkbox"/>	<input checked="" type="checkbox"/>	<input checked="" type="checkbox"/>
System Shutdown	<input checked="" type="checkbox"/>	<input checked="" type="checkbox"/>	<input checked="" type="checkbox"/>
System Reboot	<input checked="" type="checkbox"/>	<input checked="" type="checkbox"/>	<input checked="" type="checkbox"/>
System Firmware Upgrade Successful	<input checked="" type="checkbox"/>	<input checked="" type="checkbox"/>	<input checked="" type="checkbox"/>
System Firmware Upgrade Fail	<input checked="" type="checkbox"/>	<input checked="" type="checkbox"/>	<input checked="" type="checkbox"/>
Management Add Device	<input checked="" type="checkbox"/>	<input checked="" type="checkbox"/>	<input checked="" type="checkbox"/>
Management Delete Device	<input checked="" type="checkbox"/>	<input checked="" type="checkbox"/>	<input checked="" type="checkbox"/>
Management Device Connect	<input checked="" type="checkbox"/>	<input checked="" type="checkbox"/>	<input checked="" type="checkbox"/>
Management Device Disconnect	<input checked="" type="checkbox"/>	<input checked="" type="checkbox"/>	<input checked="" type="checkbox"/>
Management Device Set Profile	<input checked="" type="checkbox"/>	<input checked="" type="checkbox"/>	<input checked="" type="checkbox"/>
Management Device Profiles Setting Done	<input checked="" type="checkbox"/>	<input checked="" type="checkbox"/>	<input checked="" type="checkbox"/>
Management Device Profiles Setting Failed	<input checked="" type="checkbox"/>	<input checked="" type="checkbox"/>	<input checked="" type="checkbox"/>
Web Login	<input checked="" type="checkbox"/>	<input checked="" type="checkbox"/>	<input checked="" type="checkbox"/>

[Alert Configuration]

System Menu – System Configuration

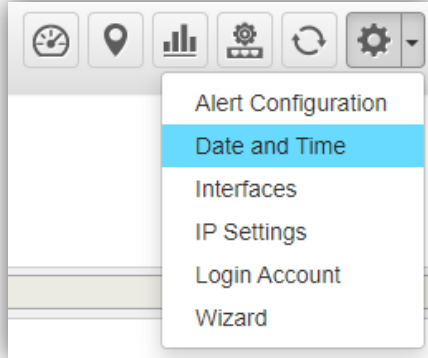

[System Menu – System Configuration]

- **Date and Time:** On this page, you can configure the Date and Time by NTP server or manual setting.
- After configuration is done, click “Apply” to apply the setting.

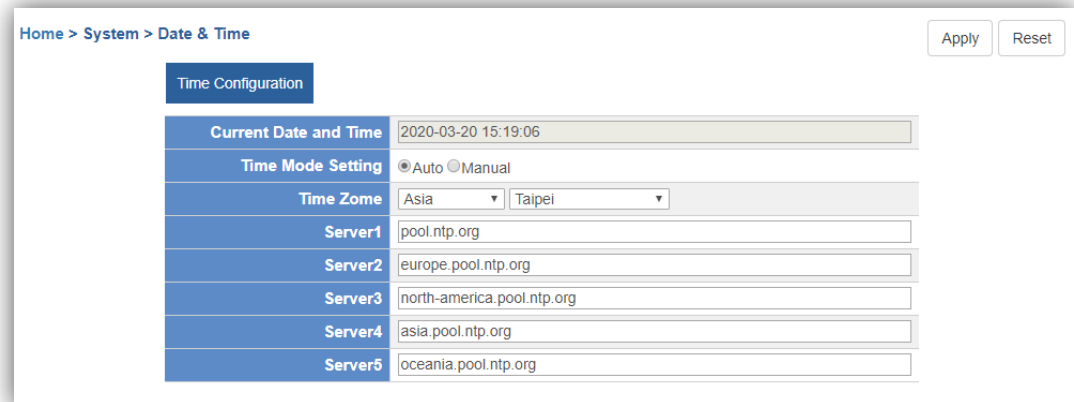

A screenshot of the 'Date & Time' configuration page. The breadcrumb trail is 'Home > System > Date & Time'. The page title is 'Time Configuration'. There are 'Apply' and 'Reset' buttons in the top right corner. The configuration fields are as follows:

Time Configuration	
Current Date and Time	2020-03-20 15:19:06
Time Mode Setting	<input checked="" type="radio"/> Auto <input type="radio"/> Manual
Time Zone	Asia <input type="text"/> Taipei <input type="text"/>
Server1	pool.ntp.org
Server2	europa.pool.ntp.org
Server3	north-america.pool.ntp.org
Server4	asia.pool.ntp.org
Server5	oceania.pool.ntp.org

[Date and Time configuration]

System Menu – System Configuration

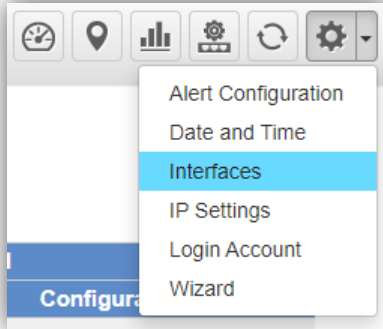

- **Interface:** On the PORT page, you can see each Port status and you can configure the speed for down, auto, 10/100 Mbps HDX/FDX, and 1GMbps FDX on the Port Statistics page.
- Click “Apply” to apply the setting.

[System Menu – System Configuration]

Port Configuration		Port Statistics		
Port	Port Description	Link	Speed	
			Current	Configuration
1	<input type="text"/>	●	Down	Auto ▾
2	<input type="text"/>	●	1Gbps FDX	Auto ▾

[Port Settings]

System Menu – System Configuration

Port	Packets		Bytes		Errors		Drops	
	Received	Transmitted	Received	Transmitted	Received	Transmitted	Received	Transmitted
1	0	0	0	0	0	0	0	0
2	478835	169696223	156746461	23195	0	420366	5201	0

[Port Statistics information]

System Menu – System Configuration

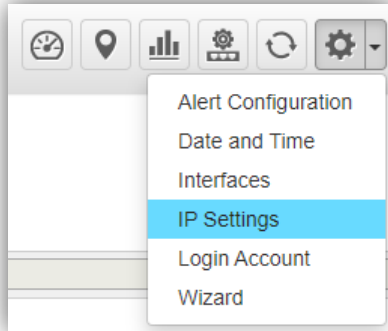

- **IP Settings:** On this page, you can configure the static ID of SAPC or choose it as DHCP client.
- After configuration is done, click “Apply” to apply the setting. The window will prompt you to change network setting that will cause the system to restart.

[System Menu – System Configuration]

Home > System > IP Settings Apply Reset

	Configuration	Status
Mode	Static IP	Static
IP Address	10.1.0.199	10.1.0.199
Subnet Mask	255.255.254.0	255.255.254.0
Default Gateway	10.1.1.254	10.1.1.254
DNS Server 1	10.1.1.3	10.1.1.3
DNS Server 2	10.1.1.4	10.1.1.4

[IP Settings]

System Menu – System Configuration

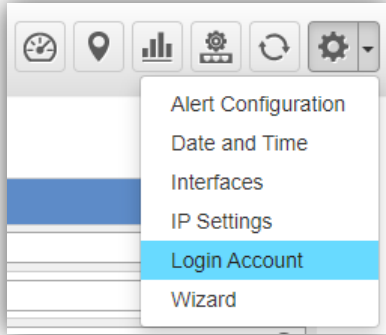

[System Menu – System Configuration]

- **Login Account:** On this page, you can modify the login user name and password.
- Enter the new user name and new password directly in the corresponding fields, and then click “Apply” to apply the setting. The login window will be prompted to ask you to enter the new account to re-log in the system.

A screenshot of the 'Edit User' configuration page. The breadcrumb trail is 'Home > System > Edit User'. The page has 'Apply' and 'Reset' buttons in the top right. The main content area is titled 'Configuration' and contains three input fields: 'User Name' with the value 'admin123', 'Password', and 'Retype Password'. Below the fields is a note: '*Please key in a new account, except using "admin" New Password must be included at least 1*[a~z], 1*[A~Z], 1*[0~9], 1*[~, !, @, ...] and must contain at least 8 character.'

[Login Account]

- ◆ *Please key in a new account, except using "admin"
- ◆ New Password must include at least 1*[a~z], 1*[A~Z], 1*[0~9], 1*[~, !, @, ...] and must contain at least 8 characters.

System Menu – System Configuration

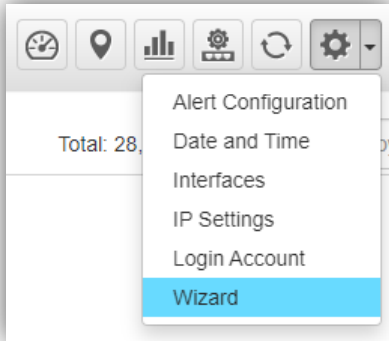

- **Wizard:** Select Wizard for setup wizard again.

[System Menu – System Configuration]

SYSTEM MENU - NETWORK SERVICES

System Menu – Network Services

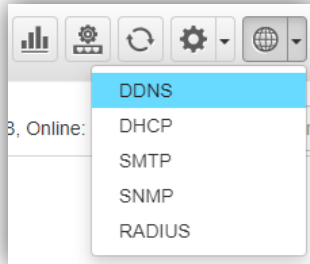

- **Network Services:** On this page, you can set up DDNS, DHCP, SMTP, SNMP, and RADIUS of the system.
- **DDNS:** Click “DDNS” to use PLANET Easy DDNS services or Dynamic DDNS. (Supports PLANET DDNS/Easy DDNS) <https://www.planetddns.com/>
- Click “Apply” to apply the setting.

[System Menu – DDNS]

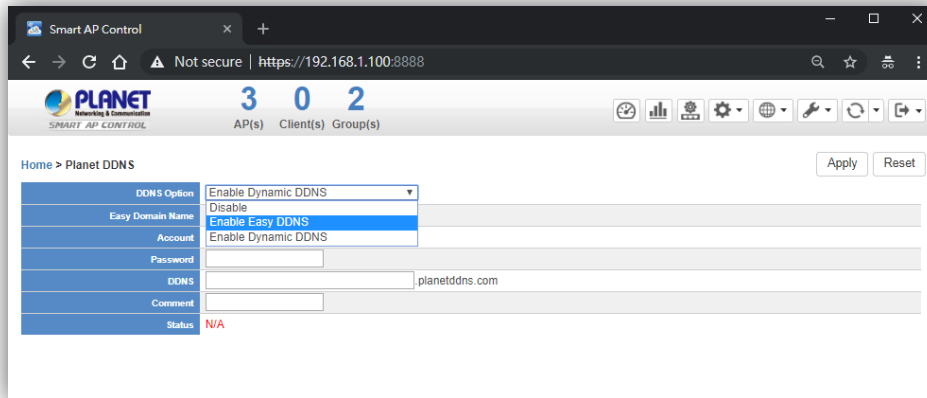

[DDNS Setting]

System Menu – Network Services

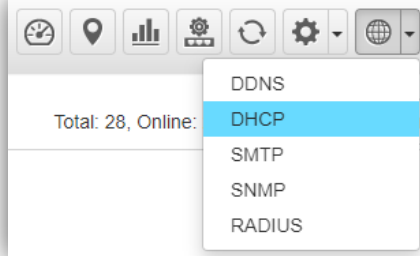

[System Menu – DHCP]

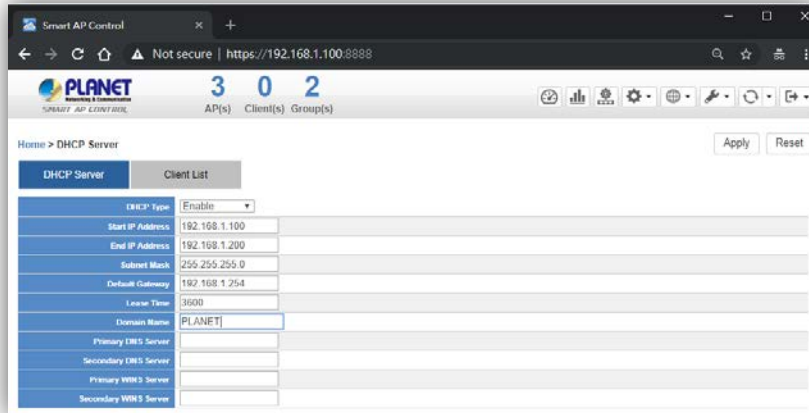

[DHCP Setting]

- **Network Services:** On this page, you can set up DDNS, DHCP, SMTP, SNMP, and RADIUS of the system.
- **DHCP:** On the DHCP Server page, choose “Enable” to use DHCP server service. On Client list page, you can see the Client detailed information.
- Click “Apply” to apply the setting.

System Menu – Network Services

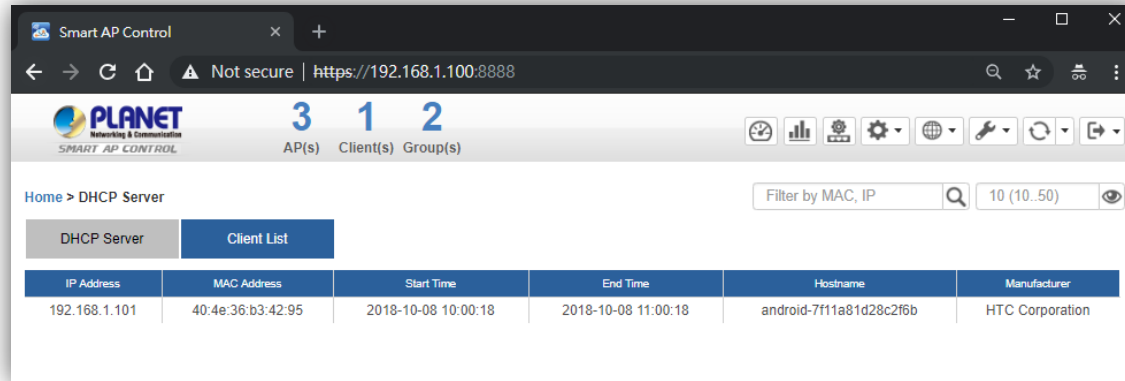

The screenshot shows the Smart AP Control web interface. The browser address bar displays `https://192.168.1.100:8888`. The interface includes a navigation menu with 'Home > DHCP Server'. Below this, there are two tabs: 'DHCP Server' and 'Client List'. A search filter is set to 'Filter by MAC, IP' with a value of '10 (10..50)'. The main content area displays a table with the following data:

IP Address	MAC Address	Start Time	End Time	Hostname	Manufacturer
192.168.1.101	40:4e:36:b3:42:95	2018-10-08 10:00:18	2018-10-08 11:00:18	android-7f11a81d28c2f6b	HTC Corporation

[Client List Information]

System Menu – Network Services

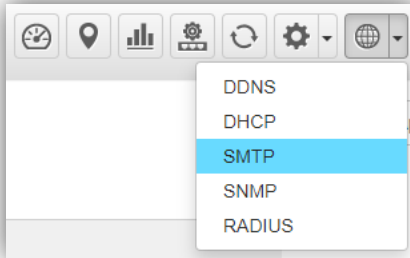

[System Menu – SMTP]

- **Network Services:** On this page, you can set up DDNS, DHCP, SMTP, SNMP, and RADIUS of the system.
- **SMTP:** On the SMTP page, choose “Enable” to use SMTP service.
- Click “Apply” to apply the setting.

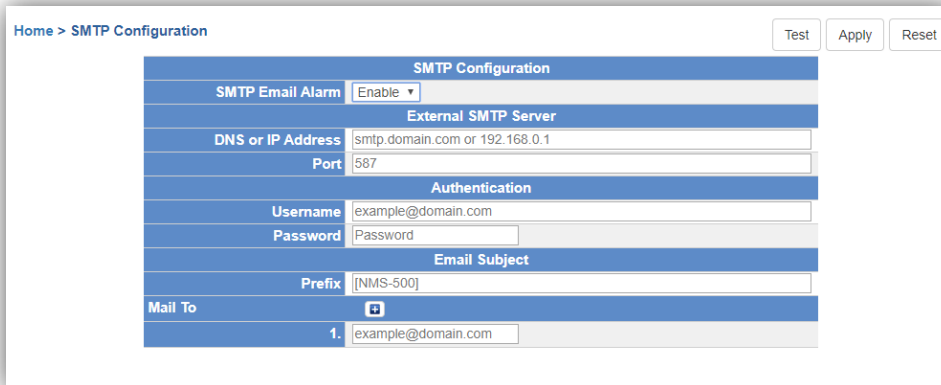

The image shows the 'SMTP Configuration' page in a web interface. The breadcrumb is 'Home > SMTP Configuration'. There are three buttons at the top right: 'Test', 'Apply', and 'Reset'. The configuration is organized into several sections:

- SMTP Configuration:** SMTP Email Alarm is set to 'Enable'.
- External SMTP Server:** DNS or IP Address is 'smtp.domain.com or 192.168.0.1' and Port is '587'.
- Authentication:** Username is 'example@domain.com' and Password is 'Password'.
- Email Subject:** Prefix is '[NMS-500]'.
- Mail To:** A list with one entry: '1. example@domain.com'.

[SMTP Setting]

System Menu – Network Services

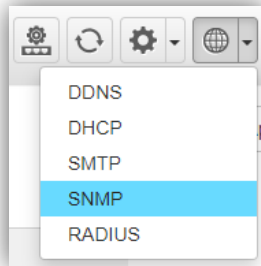

[System Menu – SNMP]

- **Network Services:** On this page, you can set up DDNS, DHCP, SMTP, SNMP, and RADIUS of the system.
- **SNMP:** On the SNMP Agent page, choose “Enable” to use SNMP v1, v2c, v3 service. On the SNMP Trap page, you can set up the SNMP Trap Configuration.
- Click “Apply” to apply the setting.

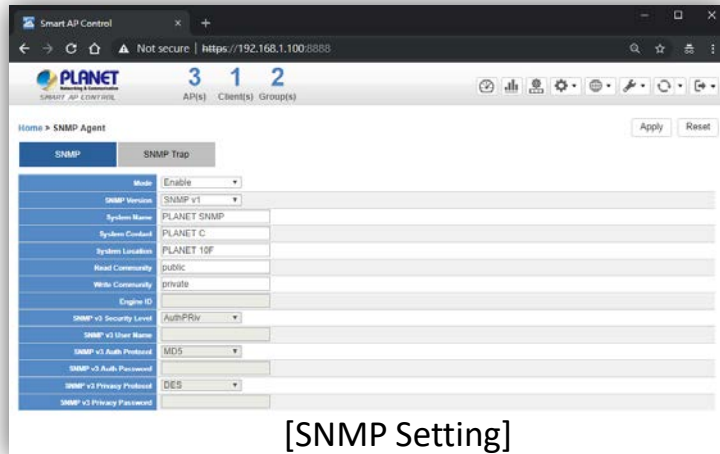

[SNMP Setting]

System Menu – Network Services

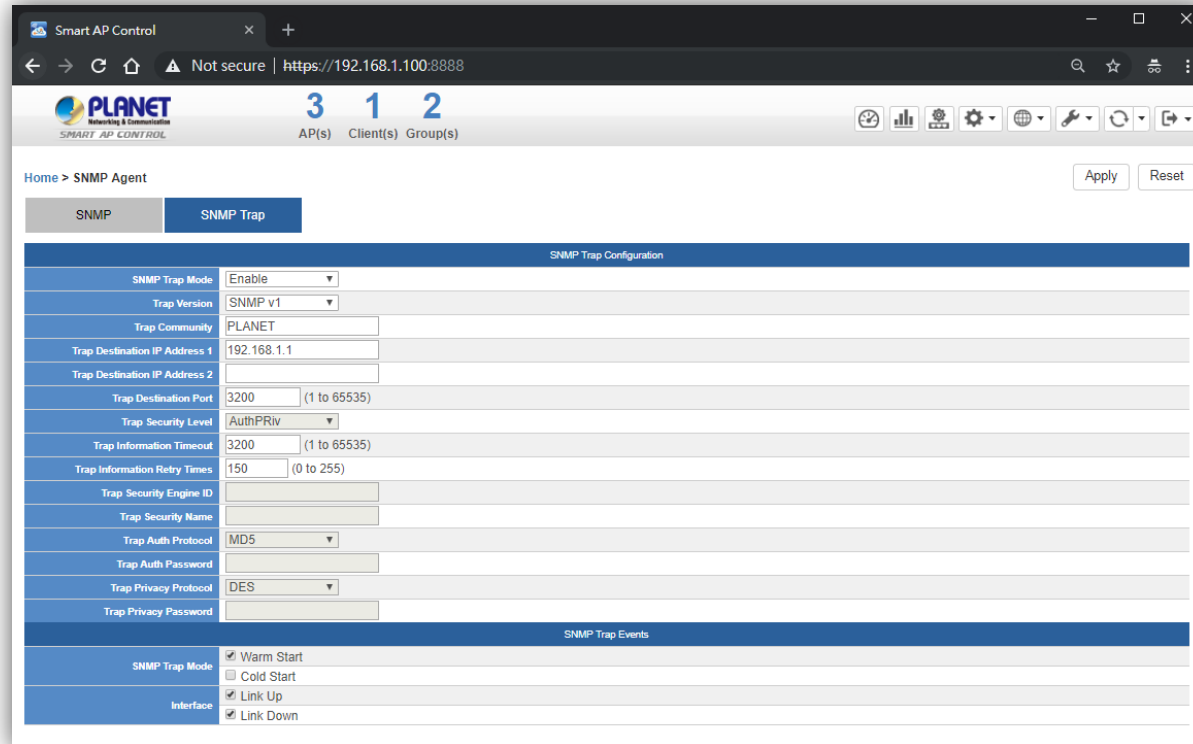

The screenshot shows the 'Smart AP Control' web interface. The browser address bar displays 'https://192.168.1.100:8888'. The interface includes a header with the PLANET logo, navigation icons, and status indicators for 3 AP(s), 1 Client(s), and 2 Group(s). The main content area is titled 'Home > SNMP Agent' and contains two tabs: 'SNMP' and 'SNMP Trap'. The 'SNMP Trap' tab is active, showing the 'SNMP Trap Configuration' section. This section includes various settings such as 'SNMP Trap Mode' (set to 'Enable'), 'Trap Version' (set to 'SNMP v1'), 'Trap Community' (set to 'PLANET'), and 'Trap Destination IP Address 1' (set to '192.168.1.1'). Other settings include 'Trap Destination IP Address 2', 'Trap Destination Port' (3200), 'Trap Security Level' (AuthPRiv), 'Trap Information Timeout' (3200), 'Trap Information Retry Times' (150), 'Trap Security Engine ID', 'Trap Security Name', 'Trap Auth Protocol' (MD5), 'Trap Auth Password', 'Trap Privacy Protocol' (DES), and 'Trap Privacy Password'. Below the configuration section is the 'SNMP Trap Events' section, which includes checkboxes for 'Warm Start', 'Cold Start', 'Link Up', and 'Link Down'.

[SNMP Trap Configuration]

System Menu – Network Services

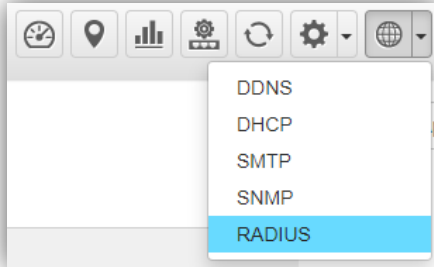

[System Menu – RADIUS]

- **Network Services:** On this page, you can set up DDNS, DHCP, SMTP, SNMP, and RADIUS of the system.
- **RADIUS:** On the RADIUS page, choose “Enable” to use RADIUS service. On RADIUS Client page and RADIUS User Account page, you can see the detailed information of them.
- Click “Apply” to apply the setting.

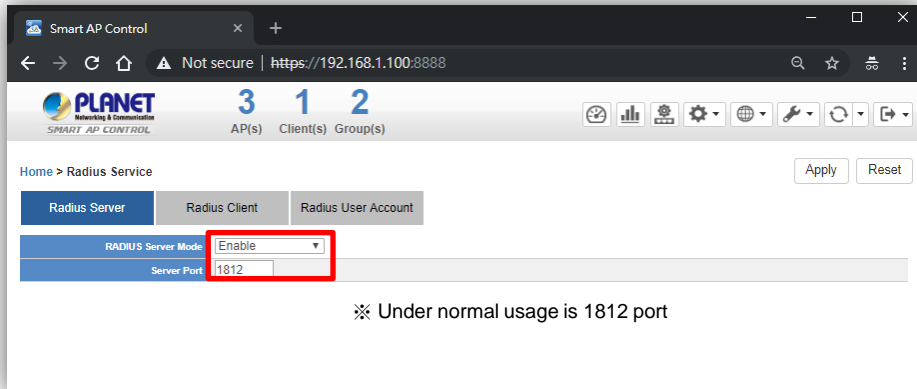

[RADIUS Setting]

System Menu – Network Services



[System Menu – RADIUS Client]

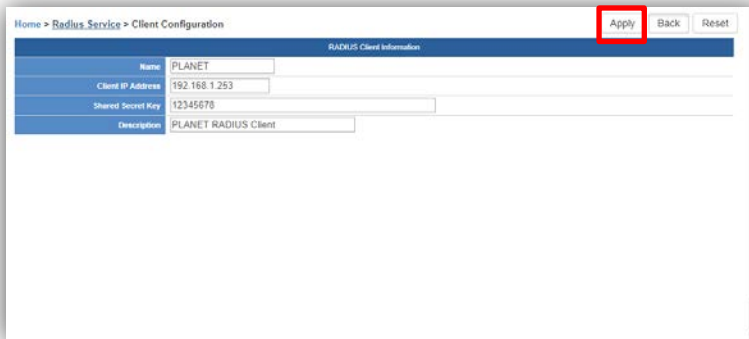

The screenshot shows the 'RADIUS Client Information' form. The 'Apply' button is highlighted with a red box. The form fields are: Name (PLANET), Client IP Address (192.168.1.253), Shared Secret Key (12345678), and Description (PLANET RADIUS Client). At the top right, there are 'Apply', 'Back', and 'Reset' buttons.

[RADIUS Client Setting]



- **Add Radius Client Configuration:** On this page, you can set up Name, Client IP, Shared Secret Key, and Description of the system.
- Click “Apply” to apply the setting.
- **AP RADIUS Setup:** You should go to AP’s Web UI to RADIUS page to set up Radius Server IP, Password and Server Port (1812), and enable the function.

System Menu – Network Services

Home > Radius Service

Filter by Name 10 (10..1024)

Radius Server Radius Client Radius User Account

	Num.	Name	Client IP Address	Secret Key	Description	Action
<input type="checkbox"/>	1	PLANET	192.168.1.253	12345678	PLANET RADIUS Client	 

Total Clients: 1

[RADIUS Client Setting Finished]

System Menu – Network Services

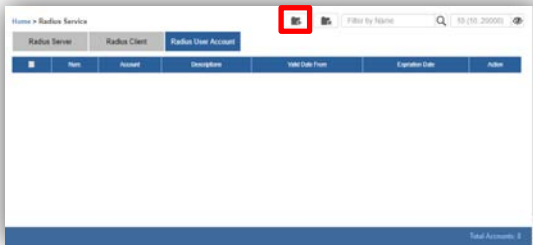

[System Menu – RADIUS]

- **Add RADIUS User Account:** On this page, you can set up Account Name, Password, Description, and Validation Period information of the system.
- Click “Apply” to apply the setting.

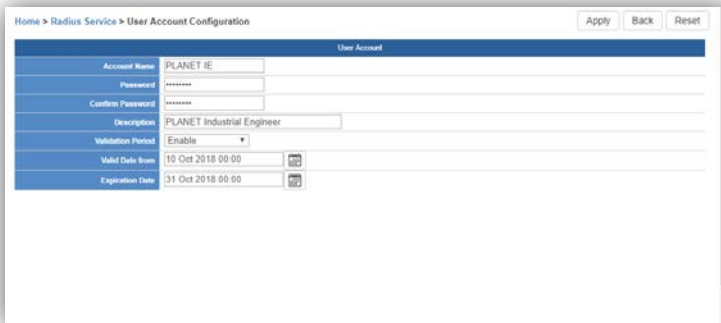



[RADIUS User Account Setting]

System Menu – Network Services

Home > Radius Service

Radius Server Radius Client **Radius User Account**

<input type="checkbox"/>	Num.	Account	Description	Valid Date From	Expiration Date	Action
<input type="checkbox"/>	1	PLANET IE	PLANET Industrial Engineer	10 Oct 2018 00:00	31 Oct 2018 00:00	 

Total Accounts: 1

[RADIUS User Account Setting Finished]

SYSTEM MENU - MAINTENANCE

System Menu – Maintenance

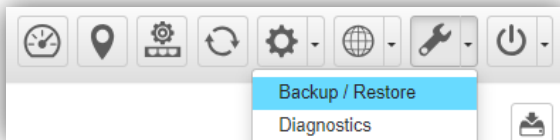

[System Menu – Maintenance]

- **Backup/Restore:** On this page, you can back up and restore the **system profiles** with the system file (*.tar.gz.enc).
- Click “backup” to start backing up the system profiles file in HDD or USB. 
- Use the “Choose File” button to choose the right system profiles file and click “restore” to start restoring the system.
- Please use the system default file name to restore system, or it may fail.

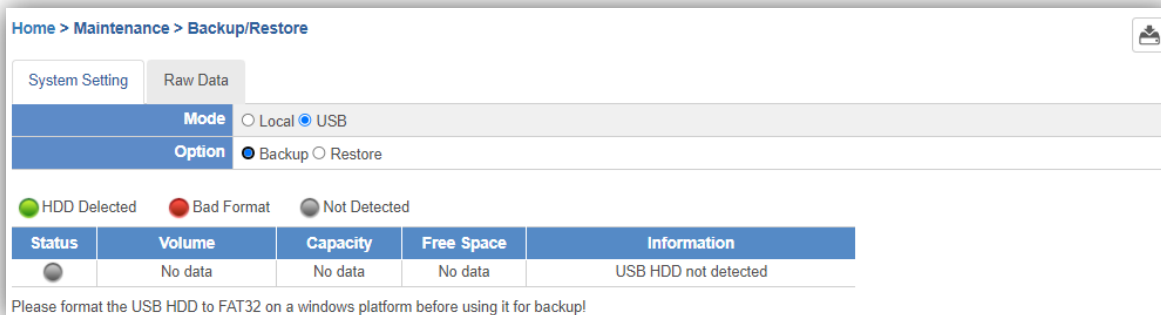

[System Setting]

System Menu – Maintenance

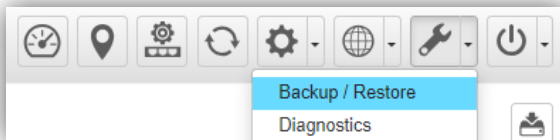

[System Menu – Maintenance]

- **Backup/Restore:** On this page, you can [back up the raw data](#) file.
 - **Auto Daily Backup:** Enable to backup raw data everyday in USB.
 - **Disk Utilization Threshold:** Hyperlink to configure the Storage Threshold page.
 - **Manual Backup:** Click button to back up raw data immediately in USB.
- ※ Installation of USB storage is required.

Home > Maintenance > Backup/Restore

Manual Backup Apply Reset

System Setting Raw Data

Auto Daily Backup Backup raw data will at 00:00 everyday, please don't shutdown the power.

Disk Utilization Threshold 85% 

● HDD Detected
 ● Bad Format
 ● Not Detected

Status	Volume	Capacity	Free Space	Information
●	No data	No data	No data	USB HDD not detected

Please format the USB HDD to FAT32 on a windows platform before using it for backup!

[Raw Data]

System Menu – Maintenance

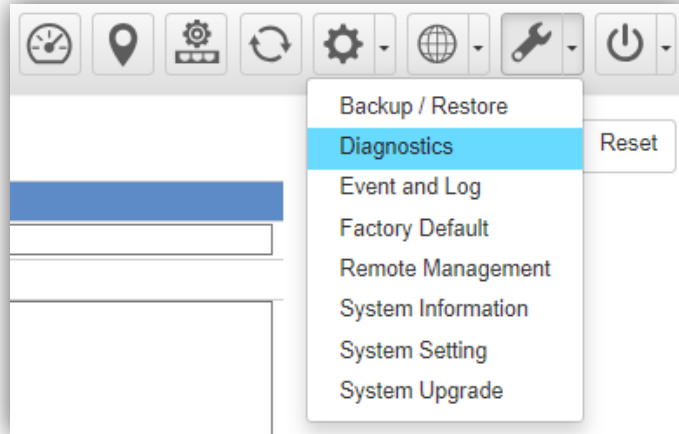

[System Menu – Maintenance]

- **Diagnostics:** On this page, you can use ping tool to ping the other devices.

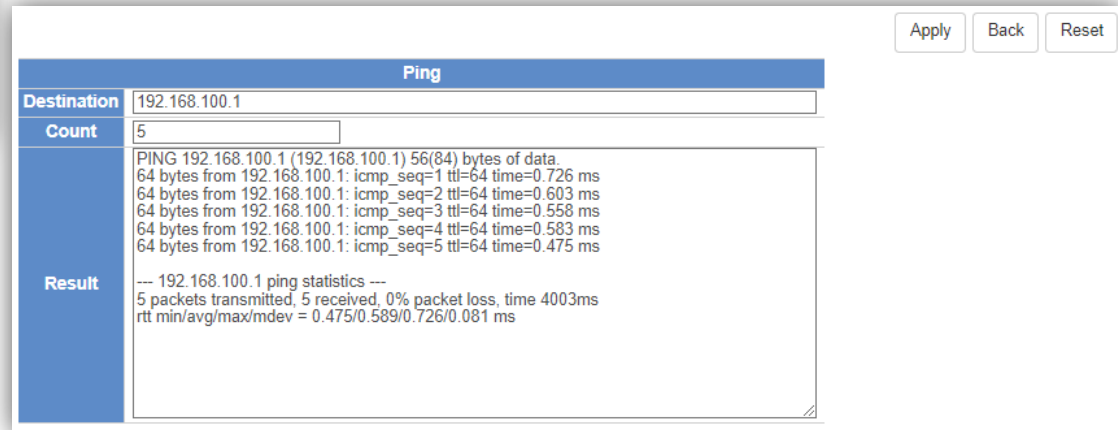

System Menu – Maintenance

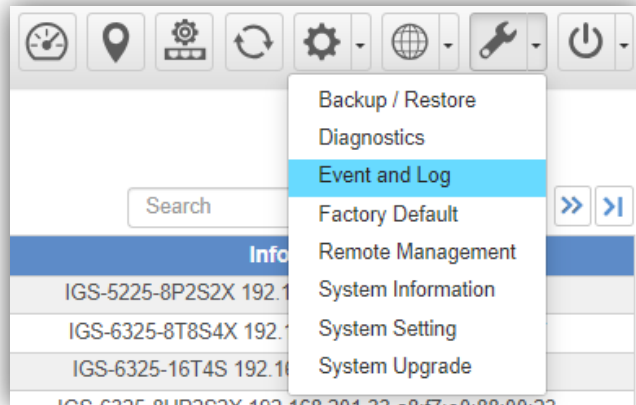

[System Menu – Maintenance]

- **Event and Log:** Click “System Setting” to **adjust the Brightness** of touch screen. (Only for NMS-1000V)
- **Search Field:** To choose the information you want by entering the key word.

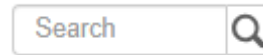

System Event

- ◆ Press the “Event” icon (No. 1) to see the full system event by day.
- ◆ Press the “<<” & “>>” icon (No. 2) to select daily report.

Home > Maintenance > Event and Log

1. **Event** Syslog 2. << 2023-11-23 >>

ID	Type	Time	Source	Status	Device Type	Information
1	System	17:31:15	192.168.100.5	Connect	Industrial Switch	IGS-6325-8T8S4X 192.168.201.31 a8:f7:e0:61:d9:9f
2	System	17:31:15	192.168.100.5	Connect	Industrial Switch	IGS-6325-8UP2S2X 192.168.201.33 a8:f7:e0:88:00:23
3	System	17:31:15	192.168.100.5	Connect	Industrial Switch	IGS-5225-8P2S2X 192.168.203.12 a8:f7:e0:74:44:91
4	System	17:31:15	192.168.100.5	Connect	Industrial Switch	IGS-6325-16T4S 192.168.201.32 a8:f7:e0:6a:6b:71
5	System	17:31:15	192.168.100.5	Disconnect	IP Power Management	EPD-1506VR-US 192.168.100.83 4c:13:65:04:eb:93
6	System	17:31:15	192.168.100.5	Disconnect	Switch	M4250-9G1F-PoE 192.168.100.194 94:18:65:65:a0:e0
7	System	17:31:15	192.168.100.5	Disconnect	IP Power Management	IPM-8221 192.168.100.84 00:50:56:c2:00:08
8	System	17:31:15	192.168.100.5	Disconnect	Industrial Switch	IGS-5225-4P2S 192.168.201.37 a8:f7:e0:61:b9:d8
9	System	17:31:15	192.168.100.5	Disconnect	Industrial Switch	IGS-5225-4T2S(v2) 192.168.201.36 a8:f7:e0:2f:10:4e
10	System	17:31:15	192.168.100.5	Disconnect	Industrial Switch	WGS-5225-8T2SV 192.168.202.41 a8:f7:e0:5b:4d:8c
11	System	17:31:04	192.168.100.5	Disconnect	Industrial Switch	IGS-5225-8P2S2X 192.168.203.12 a8:f7:e0:74:44:91
12	System	17:31:04	192.168.100.5	Disconnect	Industrial Switch	IGS-6325-8T8S4X 192.168.201.31 a8:f7:e0:61:d9:9f
13	System	17:31:04	192.168.100.5	Disconnect	Industrial Switch	IGS-6325-16T4S 192.168.201.32 a8:f7:e0:6a:6b:71

Syslog Server

- ◆ Press the “Syslog” icon (No. 1) to see the full syslog by day (Open the devices remote syslog function.).
- ◆ Press the “<<” & “>>” icon (No. 2) to select daily report.
- ◆ Press the “Drop-down” menu (No. 3) to select severity and device ID.



Click button to clear all syslog in NMS immediately.

1. 2. 3.

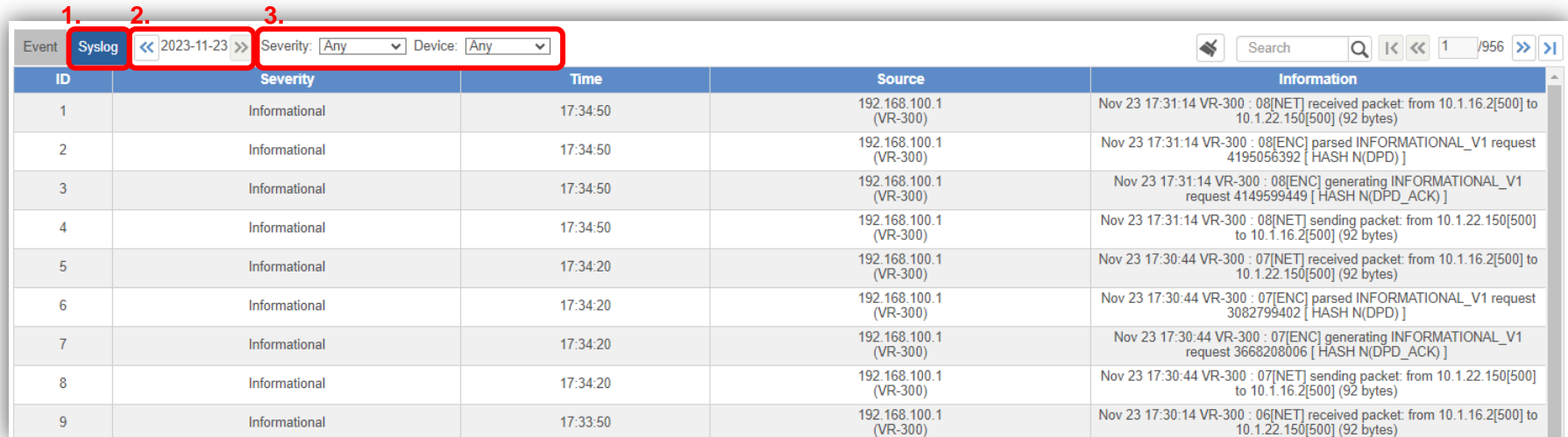

ID	Severity	Time	Source	Information
1	Informational	17:34:50	192.168.100.1 (VR-300)	Nov 23 17:31:14 VR-300 : 08[NET] received packet: from 10.1.16.2[500] to 10.1.22.150[500] (92 bytes)
2	Informational	17:34:50	192.168.100.1 (VR-300)	Nov 23 17:31:14 VR-300 : 08[ENC] parsed INFORMATIONAL_V1 request 4195056392 [HASH N(DPD)]
3	Informational	17:34:50	192.168.100.1 (VR-300)	Nov 23 17:31:14 VR-300 : 08[ENC] generating INFORMATIONAL_V1 request 4149599449 [HASH N(DPD_ACK)]
4	Informational	17:34:50	192.168.100.1 (VR-300)	Nov 23 17:31:14 VR-300 : 08[NET] sending packet: from 10.1.22.150[500] to 10.1.16.2[500] (92 bytes)
5	Informational	17:34:20	192.168.100.1 (VR-300)	Nov 23 17:30:44 VR-300 : 07[NET] received packet: from 10.1.16.2[500] to 10.1.22.150[500] (92 bytes)
6	Informational	17:34:20	192.168.100.1 (VR-300)	Nov 23 17:30:44 VR-300 : 07[ENC] parsed INFORMATIONAL_V1 request 3082799402 [HASH N(DPD)]
7	Informational	17:34:20	192.168.100.1 (VR-300)	Nov 23 17:30:44 VR-300 : 07[ENC] generating INFORMATIONAL_V1 request 3668208006 [HASH N(DPD_ACK)]
8	Informational	17:34:20	192.168.100.1 (VR-300)	Nov 23 17:30:44 VR-300 : 07[NET] sending packet: from 10.1.22.150[500] to 10.1.16.2[500] (92 bytes)
9	Informational	17:33:50	192.168.100.1 (VR-300)	Nov 23 17:30:14 VR-300 : 06[NET] received packet: from 10.1.16.2[500] to 10.1.22.150[500] (92 bytes)

System Menu – Maintenance

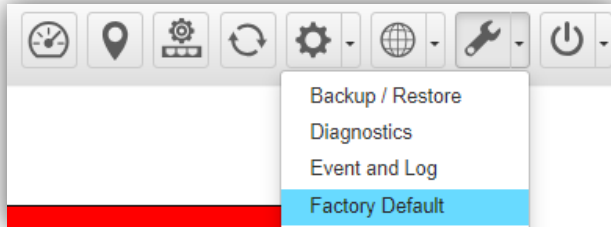

- **Factory Default:** Click “Factory Default” to reset the system to factory default. Once clicked, the warning window will prompt you to reset system to default.

[System Menu – Maintenance]

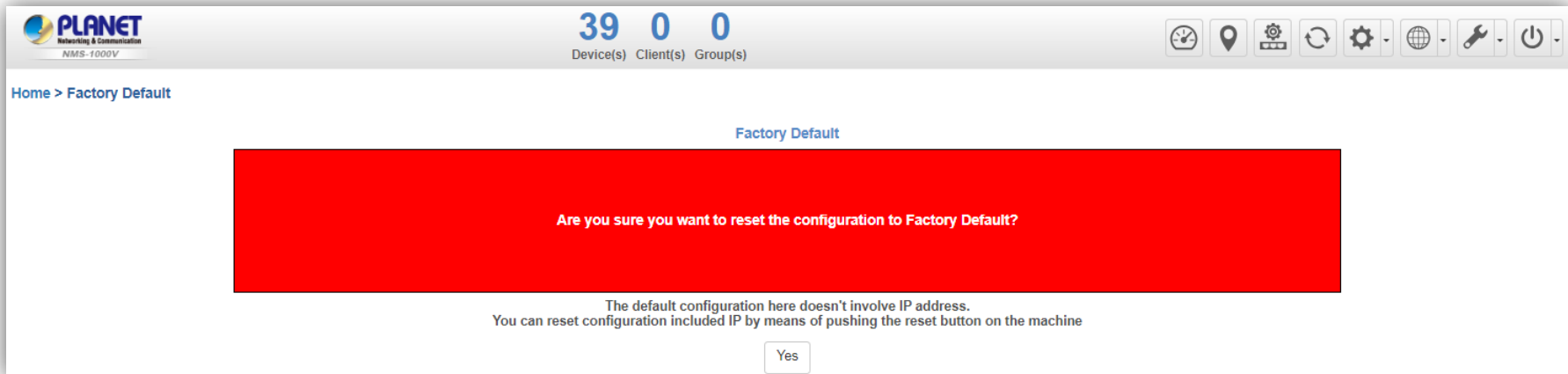

[Factory Default Warning]

System Menu – Maintenance

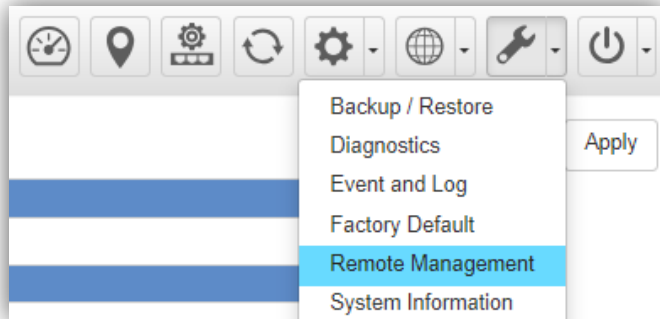

[System Menu – Maintenance]

- **Remote Management:** On this page, you can set the profile for UNC-NMS to manage the NMS-500/NMS-1000V.
- **Remote Management drop-down menu:** To select the permissions of UNC-NMS to monitor or control NMS-500/NMS-1000V.
- **Server DNS or IP Address:** Enter the UNC-NMS DNS or IP address.
- **Port:** Enter the UNC-NMS control port (default is 8887).
- **Import UNC-NMS CA:** To import the UNC-NMS CA file into NMS-500/NMS-1000V. (Account/Password/Device ID will be automatically taken out)

Home > Maintenance > Remote Management Apply

NMS Agent Configuration	
Remote Management	<div style="border: 1px solid gray; padding: 2px;"> Disable Enable RO Enable RW </div>
Server DNS or IP Address	<input type="text"/>
Port	<input type="text" value="8887"/>
Authentication	
Account	<input type="text" value="test"/>
Password	<input type="text" value="test"/>
Device ID	<input type="text"/>
Import UNC-NMS CA	<input type="checkbox"/> Replace CA 選擇檔案 未選擇任何檔案

[Remote Management]

System Menu – Maintenance

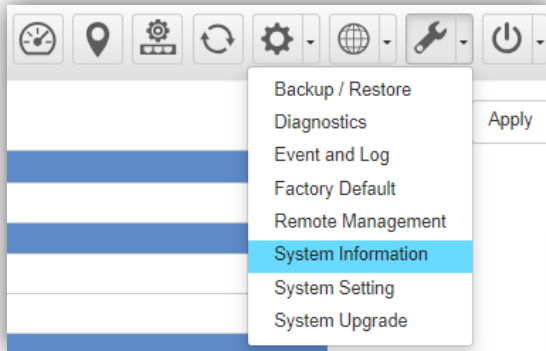

[System Menu – Maintenance]

- **System Information:** On this page, you can overview the NMS system information, just like the CPU/Disk/Memory Utilization, FW version, etc.

Home > Maintenance > System Information



0.7%
CPU Utilization



39.1%
Disk Utilization



26.2%
Memory Utilization

System Information	
Model Name	NMS-1000V
Memory	3.8 GiB
Storage	28.3 GiB
System IP Address	192.168.100.5 (Static IP)
Firmware Version	v1.0b231116
Devies Alive Status Interval	1 Min.
Wi-Fi Update Status Interval	1 Min.

Function Information			
Auto Clear Syslog	Enable	Auto Daily Backup	Disable
Planet DDNS	Disable	Radius Service	Disable
SNMP Agent	Disable	SNMP Trap	Disable
		DHCP Service	Disable
		SMTP	Disable
		Time Configuration	Auto

System Menu – Maintenance

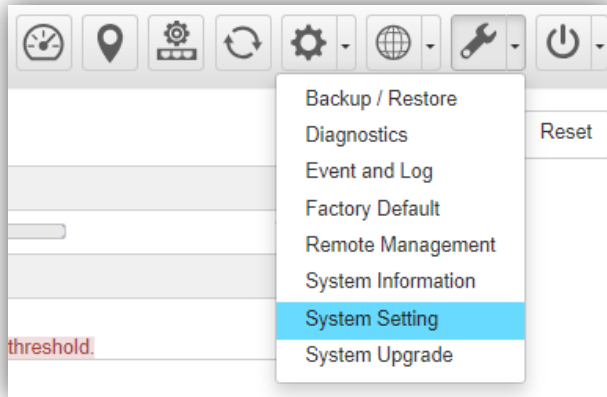

- **System Setting:** Click “System Setting” to **adjust the Brightness** of touch screen. (Only for NMS-1000V)
- **Auto Logout Time:** Set auto logout time when idle NMS Web.
- **Auto Clear Syslog:** Default enable auto clear Syslog when disk utilization reaches 85% storage threshold.
- **Storage Threshold:** Default enable auto clear Raw data when disk utilization reaches 85% storage threshold.

[System Menu – Maintenance]

Home > Maintenance > System Setting Apply Reset

Auto Logout Time	<input type="checkbox"/> Manual	5 hour
Brightness Adjust	<input type="range" value="70"/> 70	
Auto Clear Syslog	<input checked="" type="checkbox"/>	Disk Utilization 85%
Storage Threshold	<input checked="" type="checkbox"/>	Disk Utilization 85% ⓘ

To keep the system stable, auto cleaning of Raw Data in the disk is a must when it reaches the storage threshold.

System Menu – Maintenance

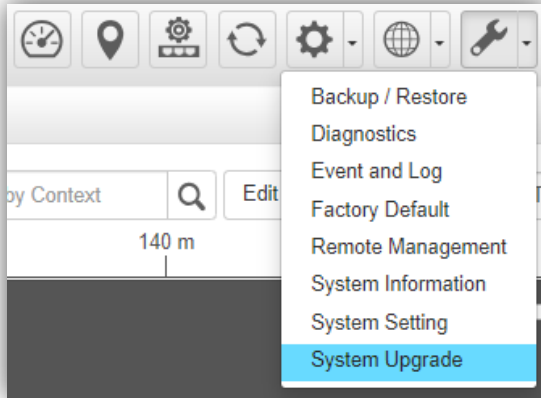

- **System Upgrade:** On this page, you can upgrade the system to the latest version with new patch.
- Click “Choose File” to designate the system patch file for upgrade. Then, click the upgrade icon at the upper-right corner to start the system upgrade.
- Please regularly check PLANET official website for the system upgrade file.

*Only by remote login be used for the NMS-1000V to do firmware upgrade.

[System Menu – Maintenance]



[System Upgrade]

SYSTEM MENU - EXIT

System Menu – Exit

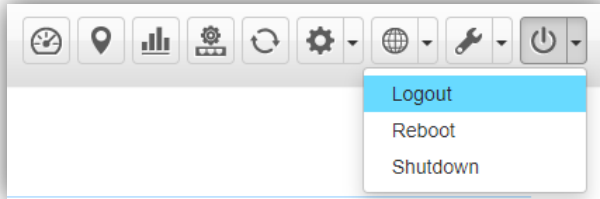

[System Menu – Logout]

- **Exit:** On this page, you can log out, reboot, or shut down the system.
- **Logout:** Click “Logout” to log out the system.
- Once clicked, the login window will prompt you to re-log in the system.



[Login Window]

System Menu – Exit

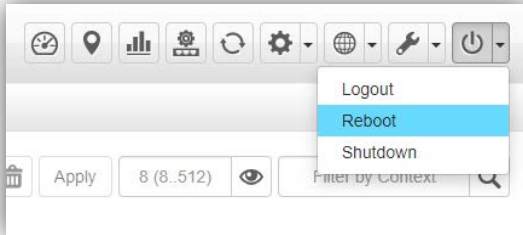

[System Menu – Reboot]

- **Logout:** On this page, you can log out, reboot, or shut down the system.
- **Reboot:** Click “Reboot” to restart the system.
- **Shutdown:** Click “Shutdown” to close the system and shut down the MV.
- Once clicked, the warning window will prompt you to reboot or shut down the system.

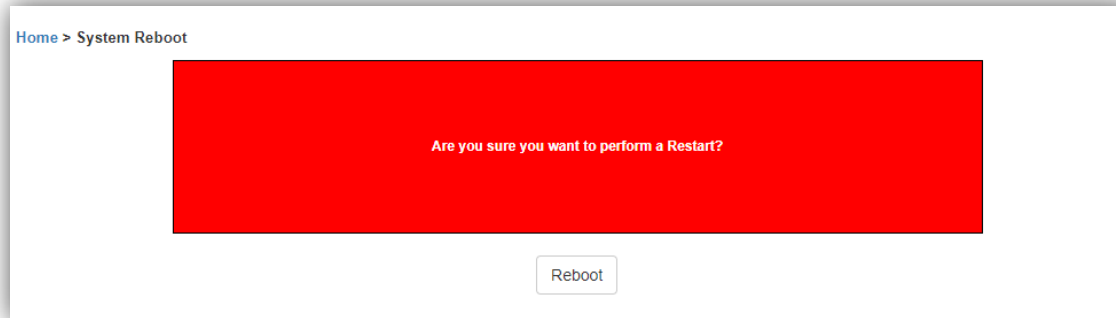

[Reboot Warning]

HDMI OUTPUT

HDMI Output

- **HDMI Output:** NMS-1000V-12 and NMS-1000V-10 support HDMI Output function.
- ※ Please follow the steps below to make sure this function works correctly.
 - 1 · Open NMS-1000 to log in page.
 - 2 · Make sure the TV or Screen supports **resolutions of 1024 x 768** for best optimization.
 - 3 · Connect NMS-1000V and TV or Screen with HDMI cable.



APPENDIX







Appendix – MQTT Devices Support List

[Please click](#)



Supported Devices

[Switch](#) / [Industrial Switch](#) / [Router](#) / [AP](#)

Photo	Model	Description	Version	Release Date	Download
Switch					
	GS-4210-24T2S	24-Port Layer 2 Managed Gigabit Ethernet Switch W/2 SFP Interfaces	v2.305b201130	2020-11-30	
	GS-4210-16T2S	16-Port Layer 2 Managed Gigabit Ethernet Switch W/2 SFP Interfaces	v2.305b200904	2020-09-04	
	GS-4210-8P2S	8-Port 10/100/1000T 802.3at PoE + 2-Port 100/1000X SFP Managed Switch	v2.305b200904	2020-09-04	

Appendix – Console

- When the “UNI-NMS login” appears, please enter user login account “adminuser”, and password “adminuser”.

```
COM6 - PuTTY
NMS-500 login: adminuser
Password:
1) View IP Status      4) Factory Default    7) Shutdown
2) Ping                5) Logout             8) System Information
3) Restart Network    6) Reboot             9) BIOS Information
Please enter your choice: 1
IP Address: 192.168.3.110
Netmask: 255.255.255.0
Gateway: 192.168.3.254
Please enter your choice: 2
Please input IP Address: 192.168.3.254
PING 192.168.3.254 (192.168.3.254) 56(84) bytes of data.
64 bytes from 192.168.3.254: icmp_seq=1 ttl=64 time=0.556 ms
64 bytes from 192.168.3.254: icmp_seq=2 ttl=64 time=0.675 ms
64 bytes from 192.168.3.254: icmp_seq=3 ttl=64 time=0.530 ms

--- 192.168.3.254 ping statistics ---
3 packets transmitted, 3 received, 0% packet loss, time 2000ms
rtt min/avg/max/mdev = 0.530/0.587/0.675/0.063 ms
Please enter your choice: 3
Restart network will take a few seconds
.....Network restart finished.
Please enter your choice: 4
[WARNING] All the configuration will lose. System will reboot at the end of fact
Do you wish to run factory default? [N/y]n
Please enter your choice: 5
```

Serial line	Speed
COM6	115200
Connection type:	
<input type="radio"/> Raw <input type="radio"/> Telnet <input type="radio"/> Rlogin <input type="radio"/> SSH <input checked="" type="radio"/> Serial	

```
NMS-500 login: adminuser
Password:
1) View IP Status      4) Factory Default    7) Shutdown
2) Ping                5) Logout             8) System Information
3) Restart Network    6) Reboot             9) BIOS Information
Please enter your choice: 8
Firmware Version:
v1.0b231002
MAC Address:
a8:f7:e0:aa:da:12
a8:f7:e0:aa:da:13
a8:f7:e0:aa:da:14
a8:f7:e0:aa:da:15
a8:f7:e0:aa:da:16
Please enter your choice: 9
BIOS Information
Vendor: American Megatrends Inc.
Version: 5.12
Release Date: 09/27/2022
Please enter your choice: █
```

www.planet.com.tw



THANK YOU